

SWX-50375330-15-4B

Waveguide Crossguide Coupler, V Band, 30 dB

SWX-50375330-15-4B is a four-port, split block crossguide coupler that is offered for power sampling where directivity is of concern. Compared to a multi-hole directional coupler, crossguide couplers offer lower insertion loss and a smaller form factor and insertion length. This model operates between 50 to 75 GHz with a 30 dB typical coupling level, 0.7 dB nominal insertion loss, and 20 dB typical directivity. The input, output, and coupled ports are all WR-15 waveguides with UG-385/U anti-cocking flanges.



Electrical Specifications:

Parameter	Minimum	Typical	Maximum
Frequency	50 GHz		75 GHz
Insertion Loss*		0.7 dB	
Coupling		30 dB	
Directivity		20 dB	
Return Loss		26 dB	
Specification Temperature		+25°C	
Operating Temperature	-40°C		+85°C

*Performance may be reduced at band edges.

Mechanical Specifications:

Item	Specification
Waveguide Ports	WR-15 Waveguide with UG-385/U Anti-Cocking Flange
Material	Aluminum
Finish	Gold Plated
Weight	0.9 Oz
Outline	WX-BV-4-F3-A

ECCN

EAR99

FEATURES

- Full Band Operation
- Low Insertion Loss
- Moderate Directivity
- Four Port Configuration

APPLICATIONS

- Test Labs
- Instrumentations
- Sub-assemblies

SUPPLEMENTAL DETAILS



SWX-50375330-15-4B

Mechanical Outline:

Unless otherwise specified, all dimensions are in inches [millimeters]

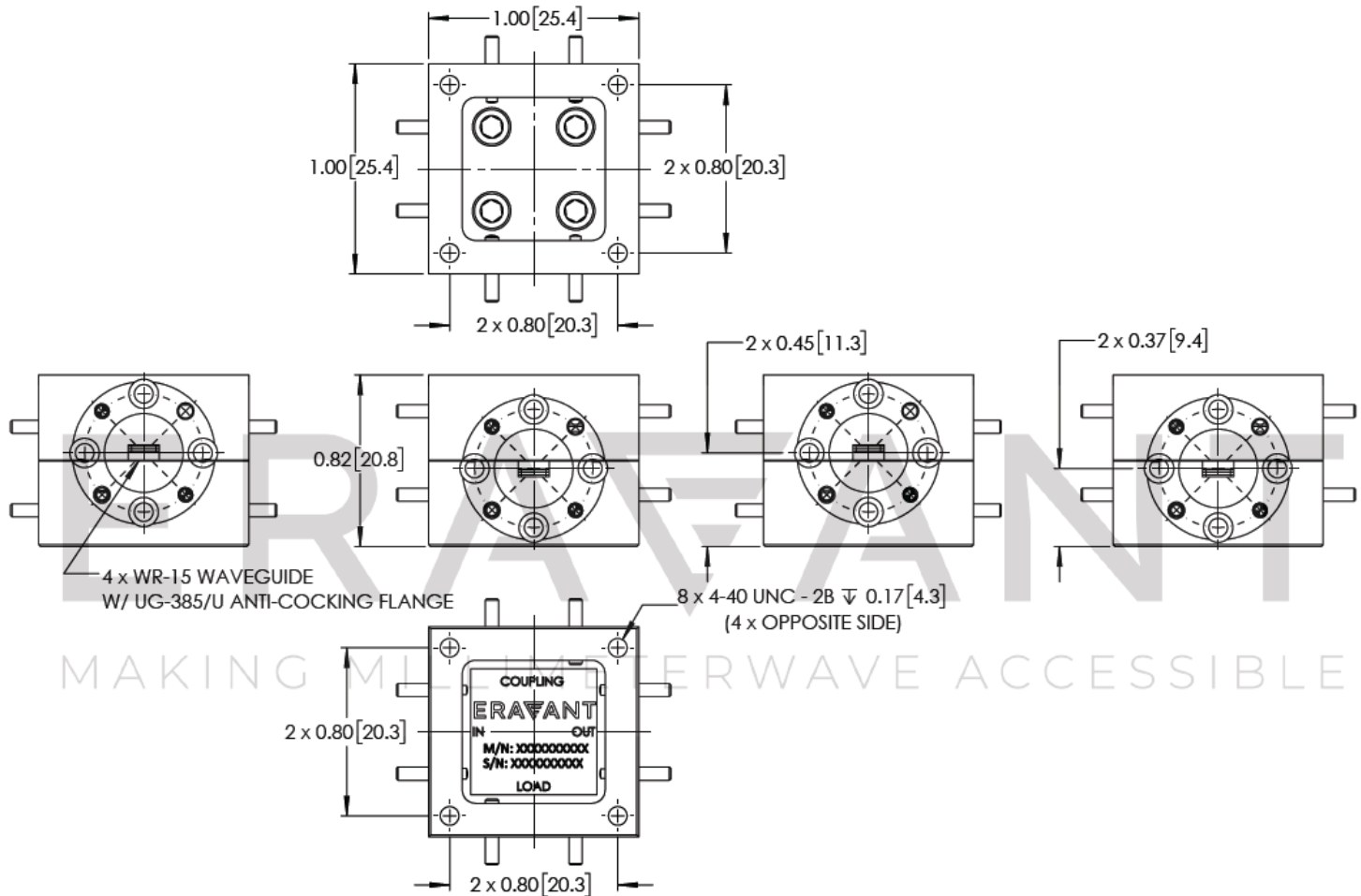

NOTE:

- On condition that test data is provided it is collected from a sample lot. Actual data may vary slightly from unit to unit. All testing is performed under +25 °C room temperature.
- On condition that simulated test data is provided, actual measured data may slightly vary.
- Eravant reserves the right to change the information presented without notice.

CAUTION:

- If a waveguide is present, any foreign objects in the waveguide will cause performance degradation and may damage or destroy the unit.