

Instrument Mini Jack, 4.0" x 4.0"

Description:

STJ-4040-S1 is an instrument mini jack that provides an adjustable support solution in laboratory environments. The mini jack is especially helpful when setting up bench top test sets or module testing systems. The jack is constructed with passivated stainless steel, featuring a 4.0 x 4.0 inch table and an elevation range of 1.6 to 5.8 inches.



Features:

- Rugged configuration
- Quick and smooth one knob adjustment
- Instrumentation grade

Applications:

- Lab apparatus support
- Test setup support
- Waveguide system support

Mechanical Specifications:

Item	Specification
Table Size (L x W)	4.0" x 4.0"
Elevation Range (H)	1.6" – 5.8"
Material	Stainless Steel
Finish	Passivated
Weight	1.4 lb
Outline	TJ-S1-3

Mechanical Outline: (Unless otherwise specified, all dimensions are in inches)

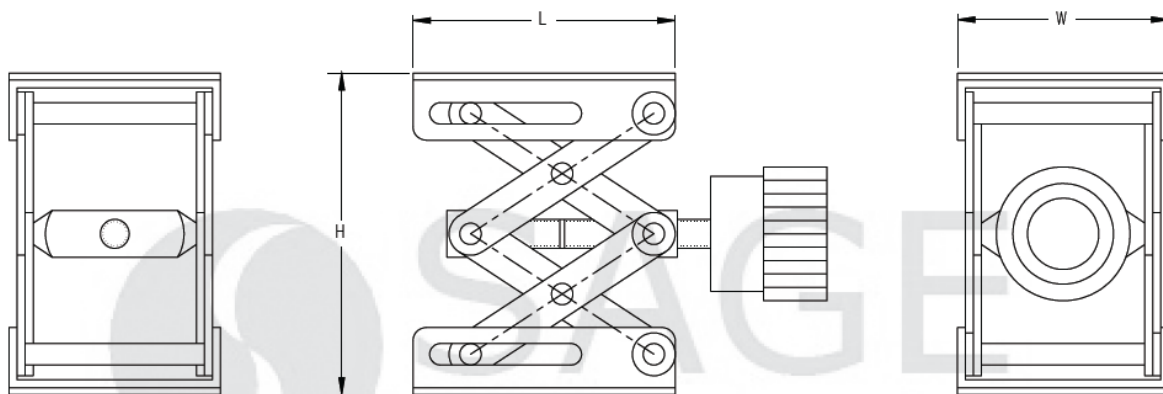

Note:

- SAGE Millimeter, Inc. reserves the right to change the information presented without notice.



www.sagemillimeter.com | 3043 Kashiwa Street, Torrance, CA 90505
 Phone: 424-757-0168 | Fax: 424-757-0188 | Email: sales@sagemillimeter.com