



## Ka-Band Compact Fixed Attenuator, 3 dB, Insertion Length 2.0"

### Description:

**Model STA-03-28-F1-C-2.0** is a compact fixed attenuator with an insertion length of 2.0". The attenuator is used in millimeterwave systems and operates from 26.5 to 40 GHz. The attenuator has a fixed attenuation value of 3 dB at the center frequency, 33.25 GHz. While the attenuator is designed and fabricated for full waveguide band applications, the attenuation value of this model does show a minor slope within the band due to its distinct mechanical configuration. Other attenuation values are available under different model numbers as **STA-XX-28-F1-C-2.0**, where **XX** is the desired attenuation value.



### Features:

- Full Band Coverage
- Low Cost
- Accurate Attenuation Value at Center Frequency
- Compact Design

### Applications:

- Test Lab
- Instrumentations
- System Integration

### Electrical Specifications:

Parameter	Minimum	Typical	Maximum
Frequency	26.5 GHz		40 GHz
Attenuation @ 33.25 GHz		3 dB	
Return Loss		20 dB	
Power Handling			0.5 W (CW)
Specification Temperature		+25 °C	
Operating Temperature	-40 °C		+85 °C

### Mechanical Specifications:

Item	Specification
Waveguide Ports	WR-28 Waveguide with UG-599/U Flange
Setting	Fixed
Insertion Length	2.00"
Material	Aluminum
Finish	Gold Plated
Weight	0.8 Oz
Outline	WF-BA





## Ka-Band Compact Fixed Attenuator, 3 dB, Insertion Length 2.0"

### Typical Attenuation vs. Frequency

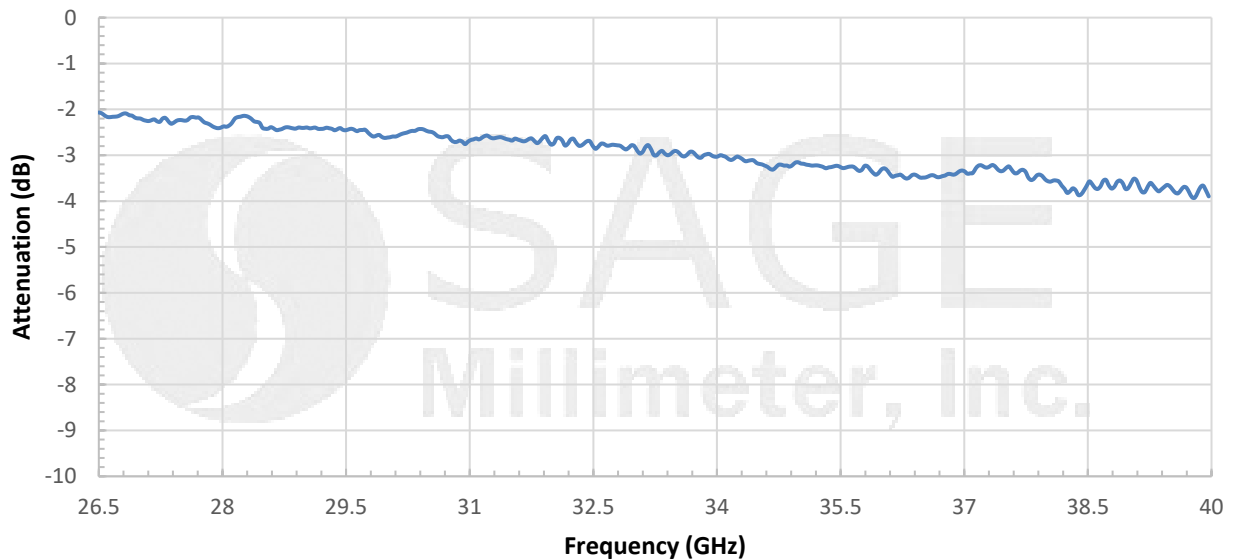

### Mechanical Outline: (Unless otherwise specified, all dimensions are in inches [millimeters])

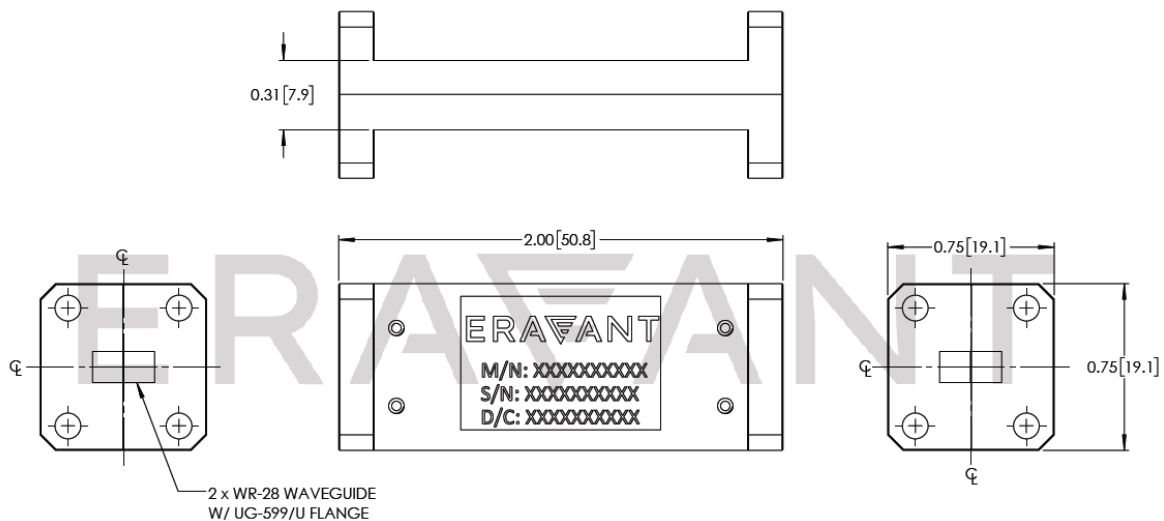

#### Note:

- All data presented is collected from a sample lot. Actual data may vary unit to unit.
- All testing was performed under +25 °C case temperature.
- SAGE Millimeter, Inc. reserves the right to change the information presented without notice.

#### Caution:

- Exceeding absolute maximum ratings will damage the device.
- Any foreign objects in the waveguide will cause performance degradation and may damage the device.

