

2.4 mm Coaxial Fixed Attenuator, 30 dB Attenuation

Description:

Model SCA-30-2M2F-S9 is a 30 dB coaxial attenuator that is used in millimeterwave systems and operates from DC to 50 GHz. The attenuator has a typical attenuation value of 30 dB across the frequency range. While the attenuator is designed and fabricated for full 2.4 mm coaxial band applications, the attenuation value of this model will have a wide range due to its broadband coverage. Various attenuation values are available under different model numbers.



Features:

- Broadband Coverage
- Low Cost

Applications:

- Test Lab
- Instrumentations
- System Integration

Electrical Specifications:

Parameter	Minimum	Typical	Maximum
Frequency	DC		50 GHz
Attenuation		30 dB	
Attenuation Accuracy		±1.1 dB	
Return Loss		17 dB	
Power Handling			2 W (CW)
Impedance		50 Ω	
Specification Temperature		+25 °C	
Operating Temperature	-40 °C		+85 °C

Mechanical Specifications:

Item	Specification
Connector 1	2.4 mm Male
Connector 2	2.4 mm Female
Body Material	Stainless Steel
Body Finish	Passivated
Connector Pin Material	Beryllium Copper
Connector Pin Finish	Gold Plated
Insulator Material	PTFE
Weight	0.3 Oz
Length	0.65"
Outline	CA-2-SR1



2.4 mm Coaxial Fixed Attenuator, 30 dB Attenuation

Typical Performance vs. Frequency

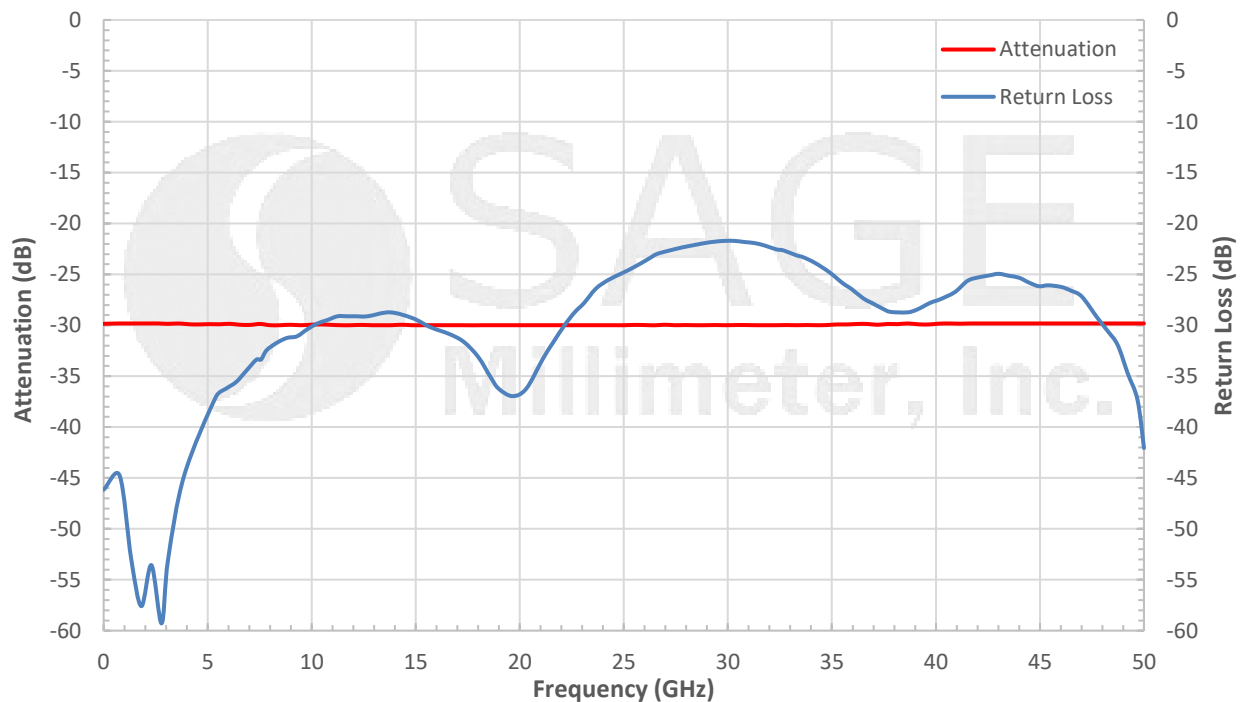

Mechanical Outline: (Unless otherwise specified, all dimensions are in inches [millimeters])

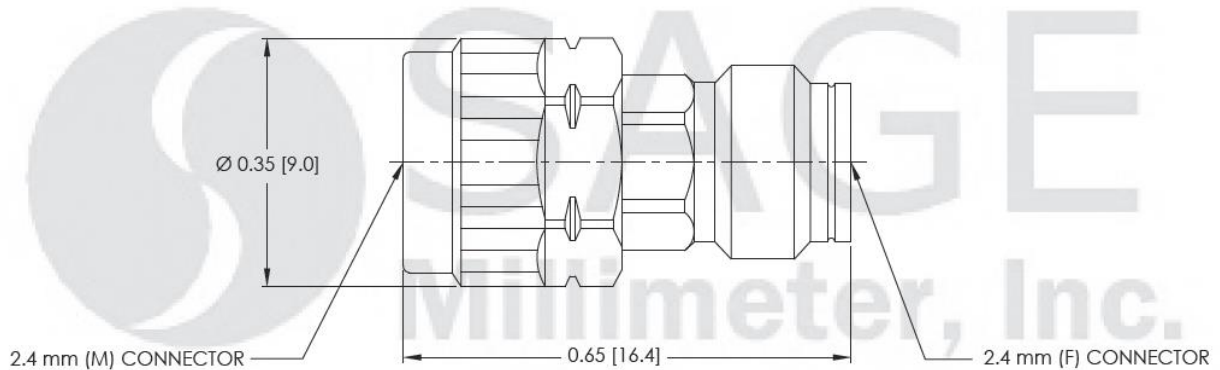

Note:

- All data presented is collected from a sample lot. Actual data may vary unit to unit, slightly.
- All testing was performed under +25 °C case temperature.
- SAGE Millimeter, Inc. reserves the right to change the information presented without notice.

Caution:

- Exceeding absolute maximum ratings shown will damage the device.
- Proper torque, 8.0 ± 0.15 inch-pounds (0.90 ± 0.02 Nm), should be applied. **SAGE Millimeter torque wrench, model SCH-08008-S1, is highly recommended.**

