



1.85 mm Coaxial Fixed Attenuator, 6 dB Attenuation

Description:

Model SCA-06-VMVF-S9 is a 6 dB coaxial attenuator that is used in millimeterwave systems and operates from DC to 67 GHz. The attenuator has a typical attenuation value of 6 dB across the frequency range. While the attenuator is designed and fabricated for full 1.85 mm coaxial band applications, the attenuation value of this model will have a wide range due to its broadband coverage. Various attenuation values are available under different model numbers.



Features:

- Broadband Coverage
- Low Cost

Applications:

- Test Lab
- Instrumentations
- System Integration

Electrical Specifications:

Parameter	Minimum	Typical	Maximum
Frequency	DC		67 GHz
Attenuation		6 dB	
Attenuation Accuracy		±1.25 dB	
Return Loss		14 dB	
Power Handling			2 W (CW)
Impedance		50 Ω	
Specification Temperature		+25 °C	
Operating Temperature	-40 °C		+85 °C

Mechanical Specifications:

Item	Specification
Connector 1	1.85 mm Male
Connector 2	1.85 mm Female
Body Material	Stainless Steel
Body Finish	Passivated
Connector Pin Material	Beryllium Copper
Connector Pin Finish	Gold Plated
Insulator Material	PTFE
Weight	0.3 Oz
Length	1.06"
Outline	CA-V-SR1



1.85 mm Coaxial Fixed Attenuator, 6 dB Attenuation

Typical Performance vs. Frequency

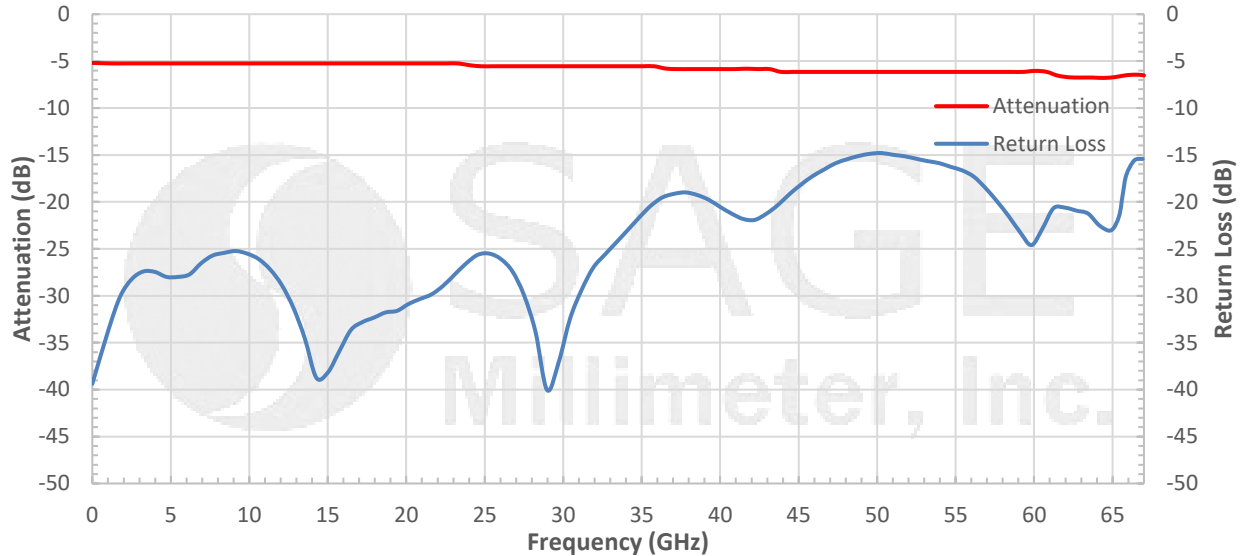

Mechanical Outline: (Unless otherwise specified, all dimensions are in inches [millimeters])

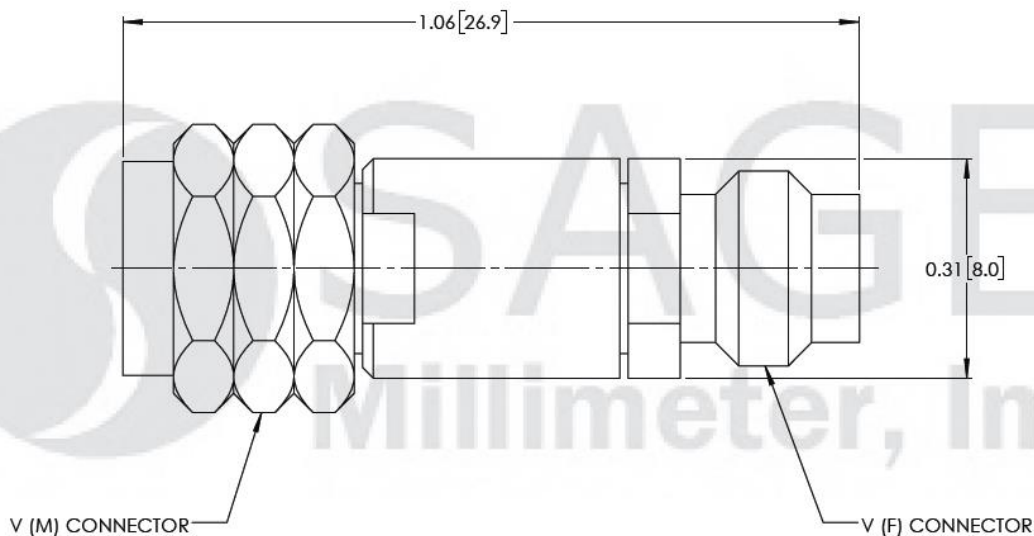

Note:

- All data presented is collected from a sample lot. Actual data may vary unit to unit, slightly.
- All testing was performed under +25 °C case temperature.
- SAGE Millimeter, Inc. reserves the right to change the information presented without notice.

Caution:

- Exceeding absolute maximum ratings shown will damage the device.
- Proper torque, 8.0 ± 0.15 inch-pounds (0.90 ± 0.02 Nm), should be applied. **SAGE Millimeter torque wrench, model SCH-08008-S1, is highly recommended.**



www.sagemillimeter.com | 3043 Kashiwa Street, Torrance, CA 90505
 Phone: 424-757-0168 | Fax: 424-757-0188 | Email: sales@sagemillimeter.com