



Dual-Ridged Horn Antenna, 14 to 110 GHz

Description:

Model SAV-1431141535-1F-U5 is a dual-ridged broadband horn antenna that operates from 14 to 110 GHz. The antenna offers a typical gain of 15 dBi and a typical 3 dB beamwidth of 35° on both the E-plane and H-plane, respectively. The antenna supports linear polarized waveforms. The antenna features a compact design and provides two M2 holes and a mounting fixture and plate for flexible mounting capacity. The RF port is equipped with a female 1 mm connector.



Features:

- Broadband Operation
- Coaxial Connector for RF Input
- Linear Polarization
- Good Impedance Match

Applications:

- Antenna Ranges
- Antenna Gain Measurements
- System Setups

Electrical Specifications:

Parameter	Minimum	Typical	Maximum
Frequency	14 GHz		110 GHz
Gain		15 dBi	
Polarization		Linear	
E-Plane 3 dB Beamwidth		35°	
H-Plane 3 dB Beamwidth		35°	
E-Plane Sidelobe Levels		-10 dB	
H-Plane Sidelobe Levels		-15 dB	
Return Loss		10 dB	
Cross Polarization	23 dB	28 dB	
Power Handling			4 W (CW)
Specification Temperature		+25°C	
Operating Temperature	-40°C		+85°C

Mechanical Specifications:

Item	Specification
Antenna Port	1 mm (F)
Mounting	2x M2 holes, Mounting Fixture and Plate
Material	Aluminum
Antenna Finish	Gold Plated
Weight	0.8 Oz
Size	1.25" (L) X 0.73" (W) X 0.61" (H)
Outline	AV-C15-DR-RS2





Dual-Ridged Horn Antenna, 14 to 110 GHz

Typical Antenna Pattern @ 14 GHz

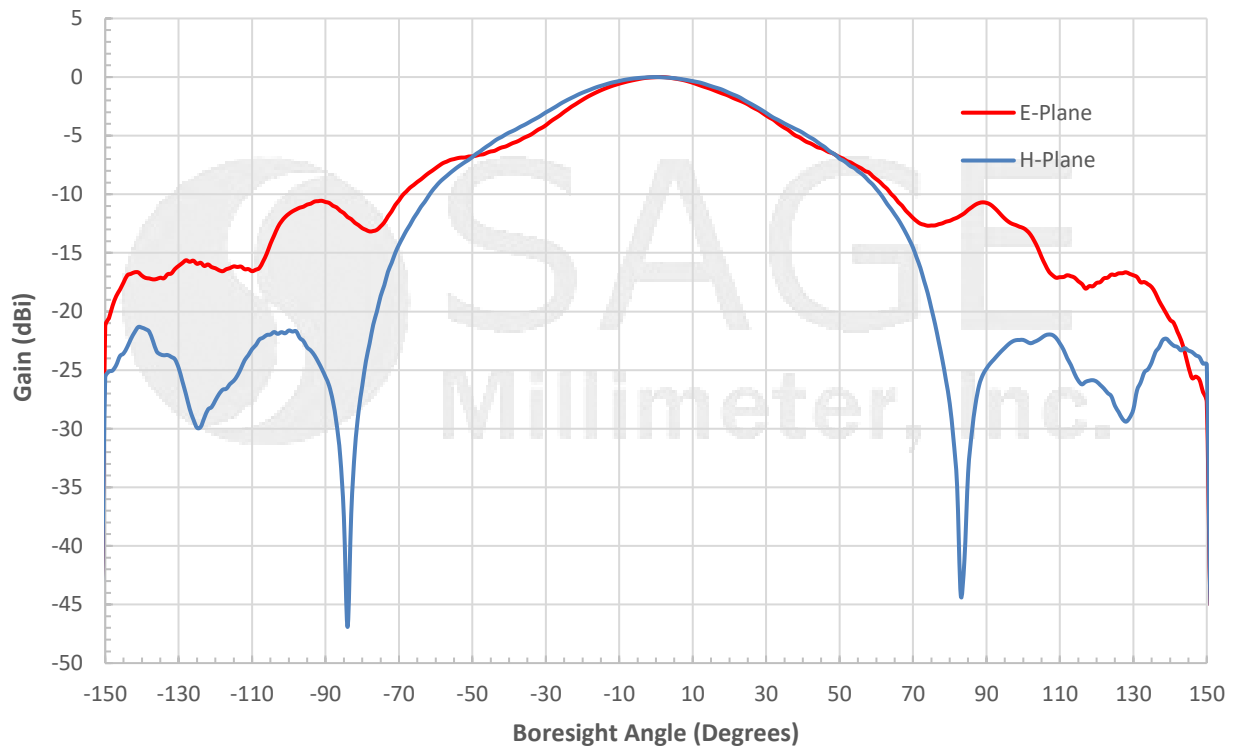

Typical Antenna Pattern @ 62 GHz

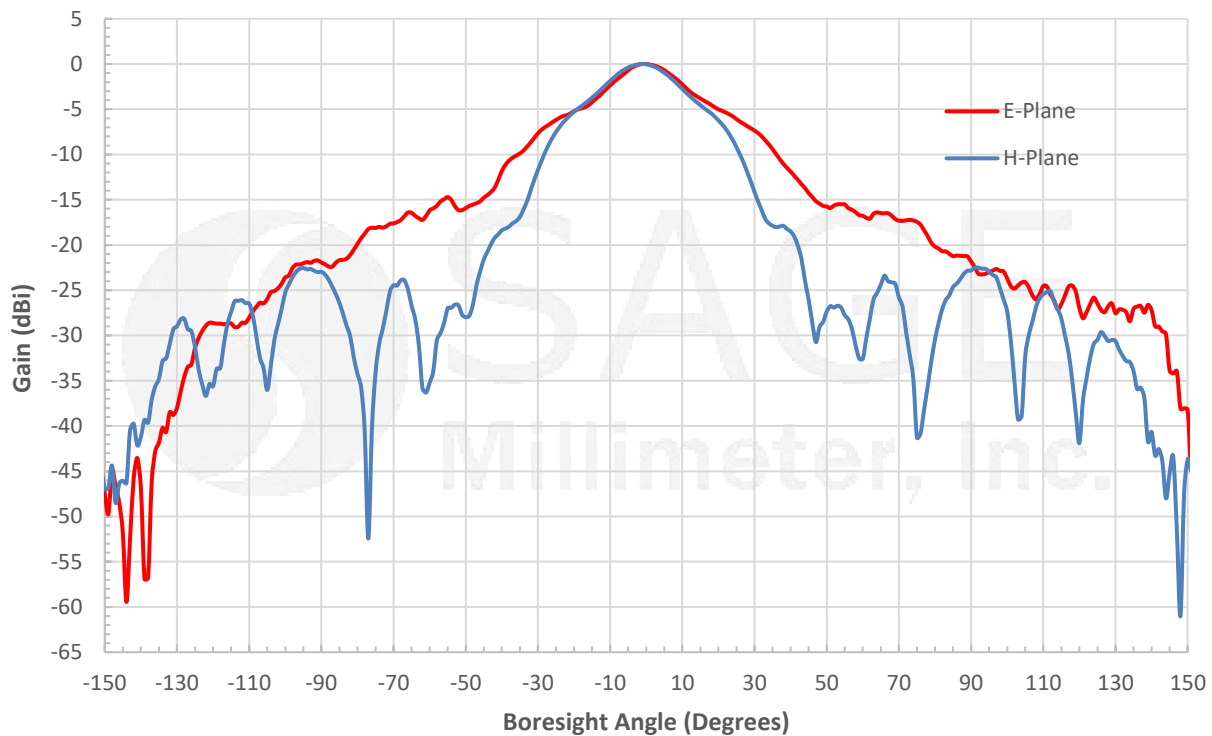



Dual-Ridged Horn Antenna, 14 to 110 GHz

Typical Antenna Pattern @ 110 GHz

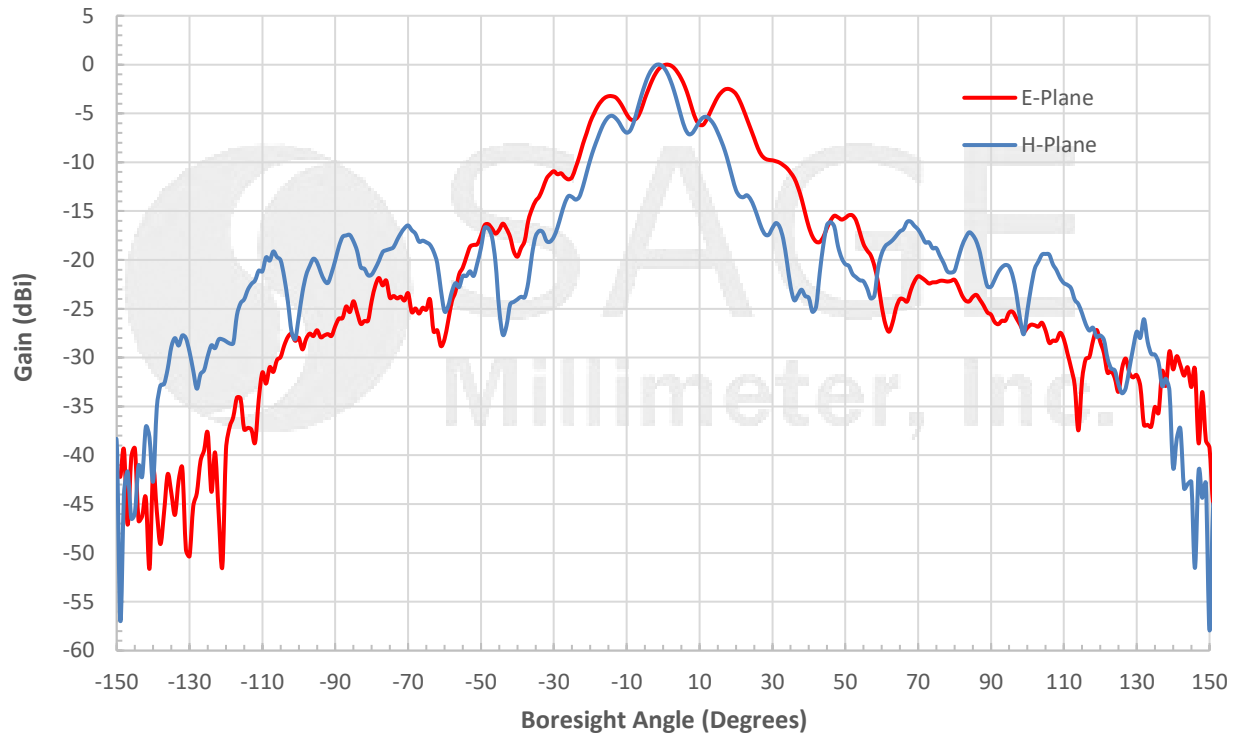

Typical Cross Polarization vs Frequency

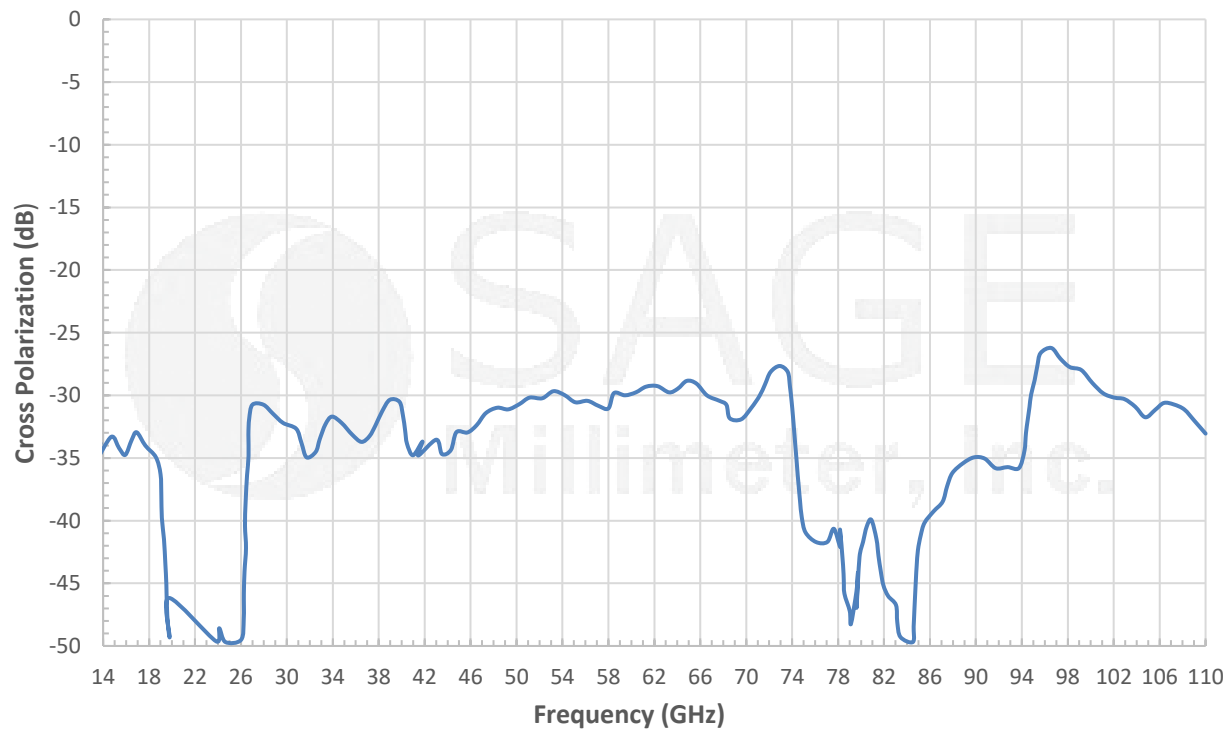



Dual-Ridged Horn Antenna, 14 to 110 GHz

Typical Gain vs. Frequency

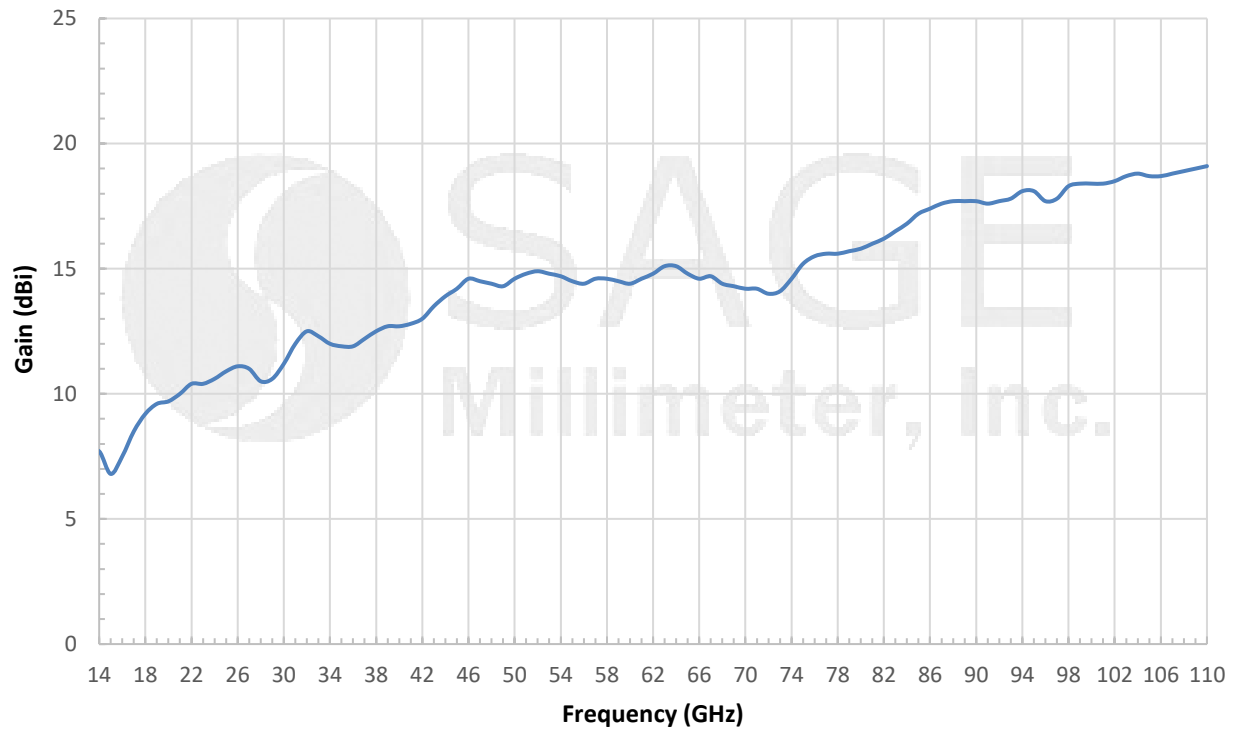

Typical 3 dB Beamwidth vs Frequency

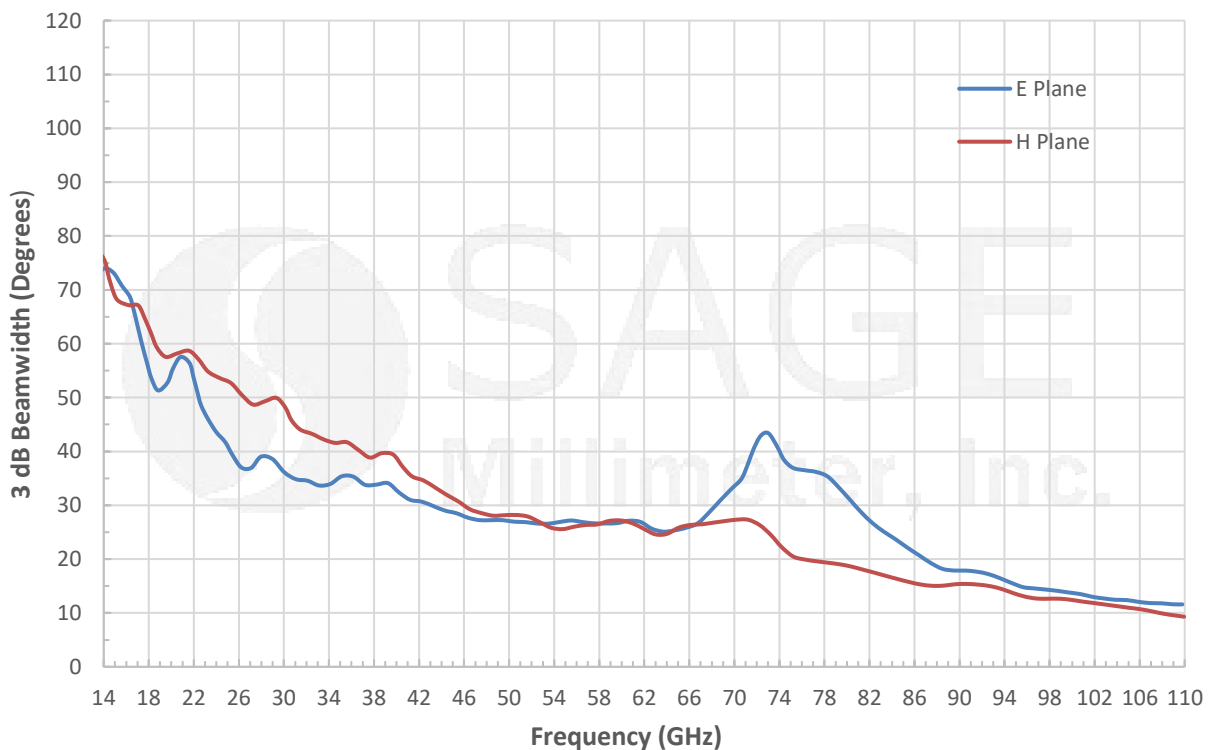



Dual-Ridged Horn Antenna, 14 to 110 GHz

Typical Return Loss vs. Frequency

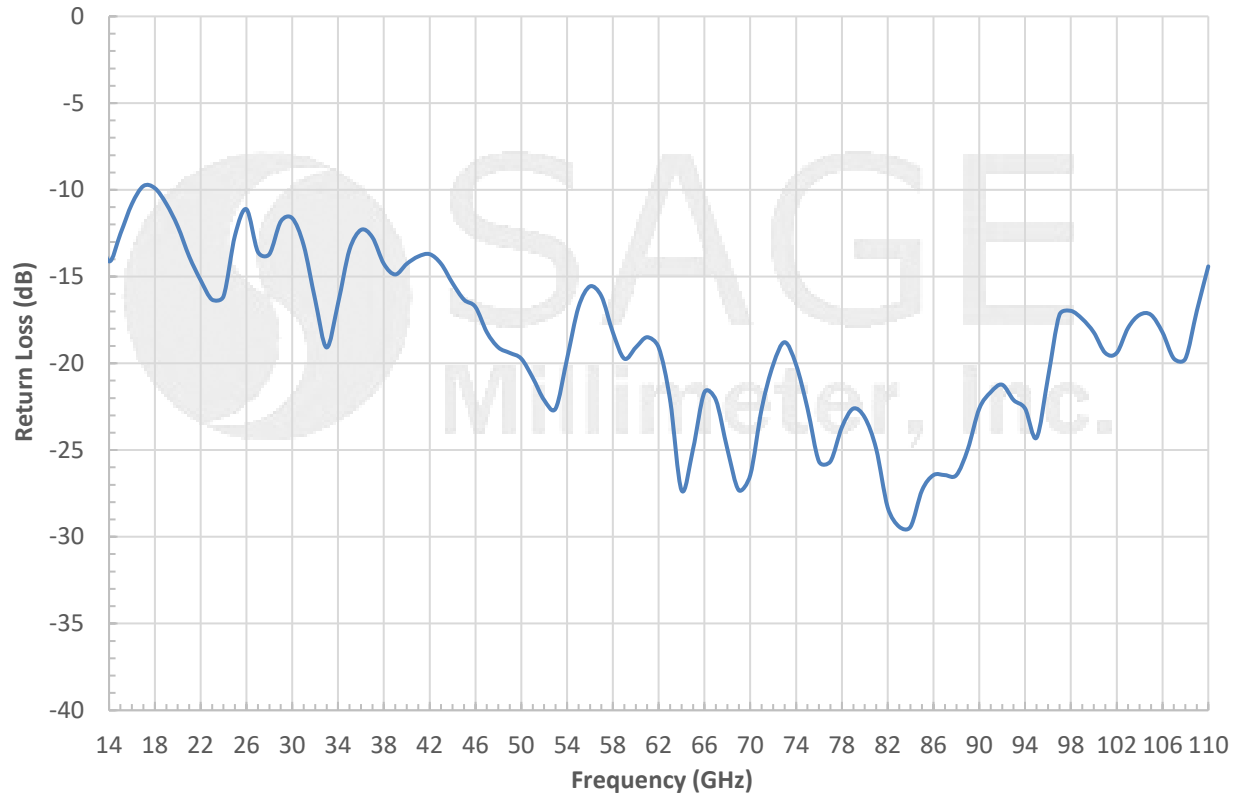

Mechanical Outline: (Unless otherwise specified, all dimensions are in inches [millimeters])

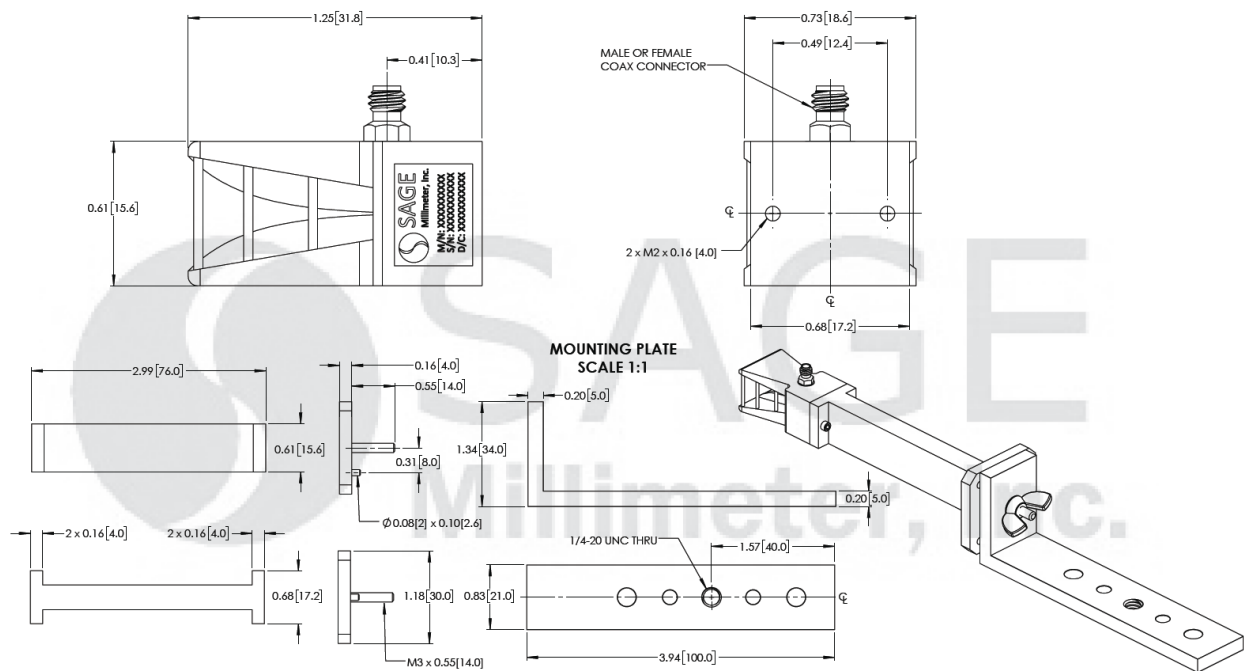

www.sagemillimeter.com | 3043 Kashiwa Street, Torrance, CA 90505
 Phone: 424-757-0168 | Fax: 424-757-0188 | Email: sales@sagemillimeter.com



Dual-Ridged Horn Antenna, 14 to 110 GHz

Note:

- All data presented is collected from a sample lot. Actual data may vary unit to unit.
- All testing was performed under +25 °C room temperature.
- SAGE Millimeter, Inc. reserves the right to change the information presented without notice.

Caution:

- Any foreign objects in the structure will cause performance degradation and possible device damage.
- Proper torque, 8.0 ± 0.15 inch-pounds (0.90 ± 0.02 Nm), should be applied. **SAGE Millimeter torque wrench, model SCH-08008-S1, is highly recommended.**

