

SAM-6837030395-15-L1-4W

V Band Microstrip Patch Array Antenna, 69 Ghz, 4 dBi, 50° x 95°

SAM-6837030395-15-L1-4W is a linear polarized, 69 GHz microstrip patch 1 x 4 array antenna. The antenna array implements four individual antenna ports so that beamforming can be achieved via various input signal definitions. The individual patch antenna has a typical gain of 4 dBi, a vertical beamwidth of 50 degrees and horizontal beamwidth of 95 degrees, respectively. When all ports are fed with in-phase and equal amplitude signals, the combined gain and beamwidth of the array are 12 dBi and 25 degrees, typically. The antenna is constructed with a high performing, low loss soft microwave substrate to achieve the best performance in the class. The RF interface is four WR-15 waveguides with UG-385/U compatible flanges.



Electrical Specifications

Parameter	Minimum	Typical	Maximum
Frequency Range	68 GHz		70 GHz
Gain (Individual Patch)		4.0 dBi	
3 dB Beamwidth (Individual Patch)	50° (Vertical, E Plane) x 95° (Horizontal, H Plane)		
Sidelobe Level (Individual Patch)		-12 dB	
Array Gain (Fed in Phase)		12.0 dBi	
Array 3 dB Beamwidth (Fed in Phase)	60° (Vertical, E Plane) x 25° (Horizontal, H Plane)		
Array Sidelobe Level (Fed in Phase)		-12 dB	
Polarization		Linear	
Return Loss		8 dB	
Specification Temperature		+25°C	
Operating Temperature	-40°C		+85°C

Mechanical Specifications:

Item	Specification
Antenna Port	4 x WR-15 Waveguide with UG-385/U Compatible Flange
Number of Elements	1 (H) x 4 (V)
Baseplate Material	Aluminum
Patch Finish	Gold Plated
Weight	2.0 Oz
Size	1.60" (L) x 1.60" (W) x 0.49" (H)
Outline	AM-RV-9550-4W

ECCN

EAR99

FEATURES

- Compact Size
- Beamforming Feasibility
- Low Cost in Volume

APPLICATIONS

- 5G Systems
- Beamforming
- Communication Systems
- Probe Stations

SUPPLEMENTAL DETAILS



SAM-6837030395-15-L1-4W

V Band Microstrip Patch Array Antenna, 69 Ghz, 4 dBi, 50° x 95°

Measured Individual Patch Pattern @ 68.17 GHz

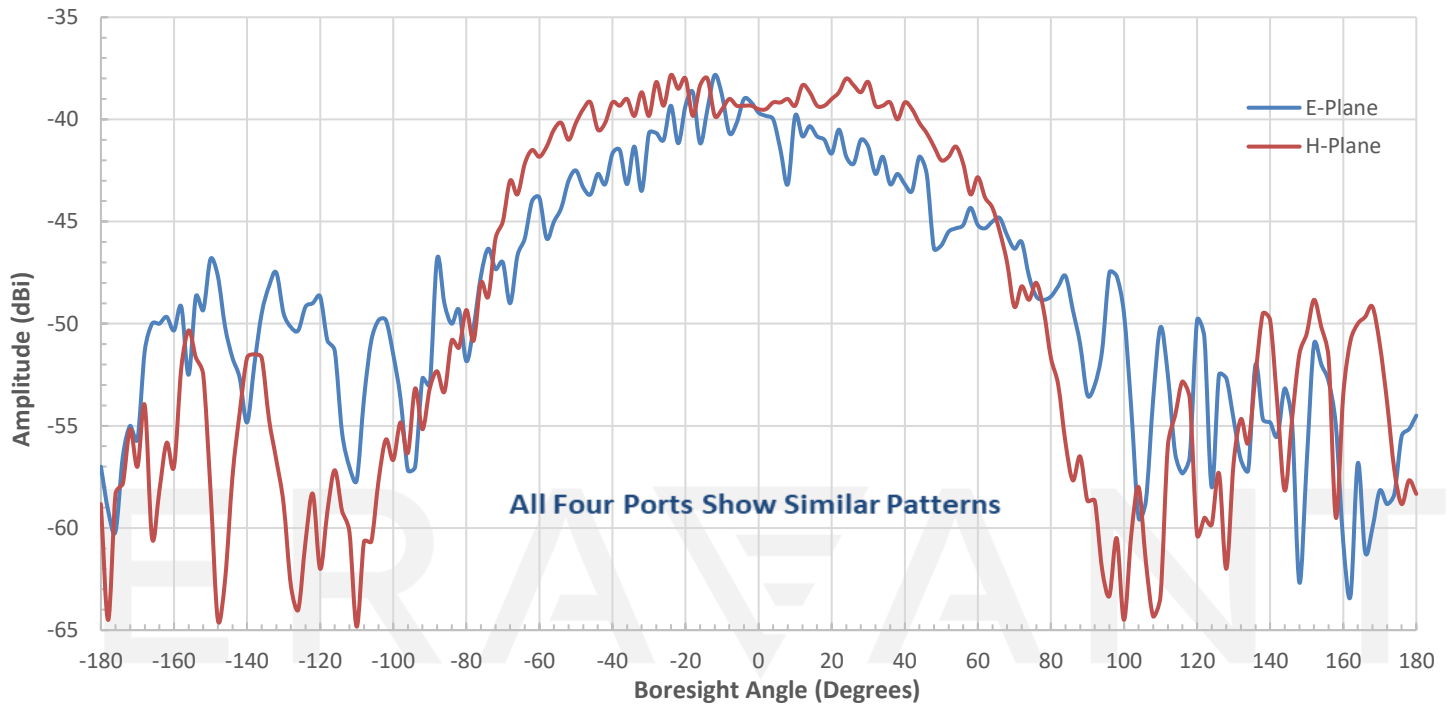

Measured Individual Patch Pattern @ 69.17 GHz

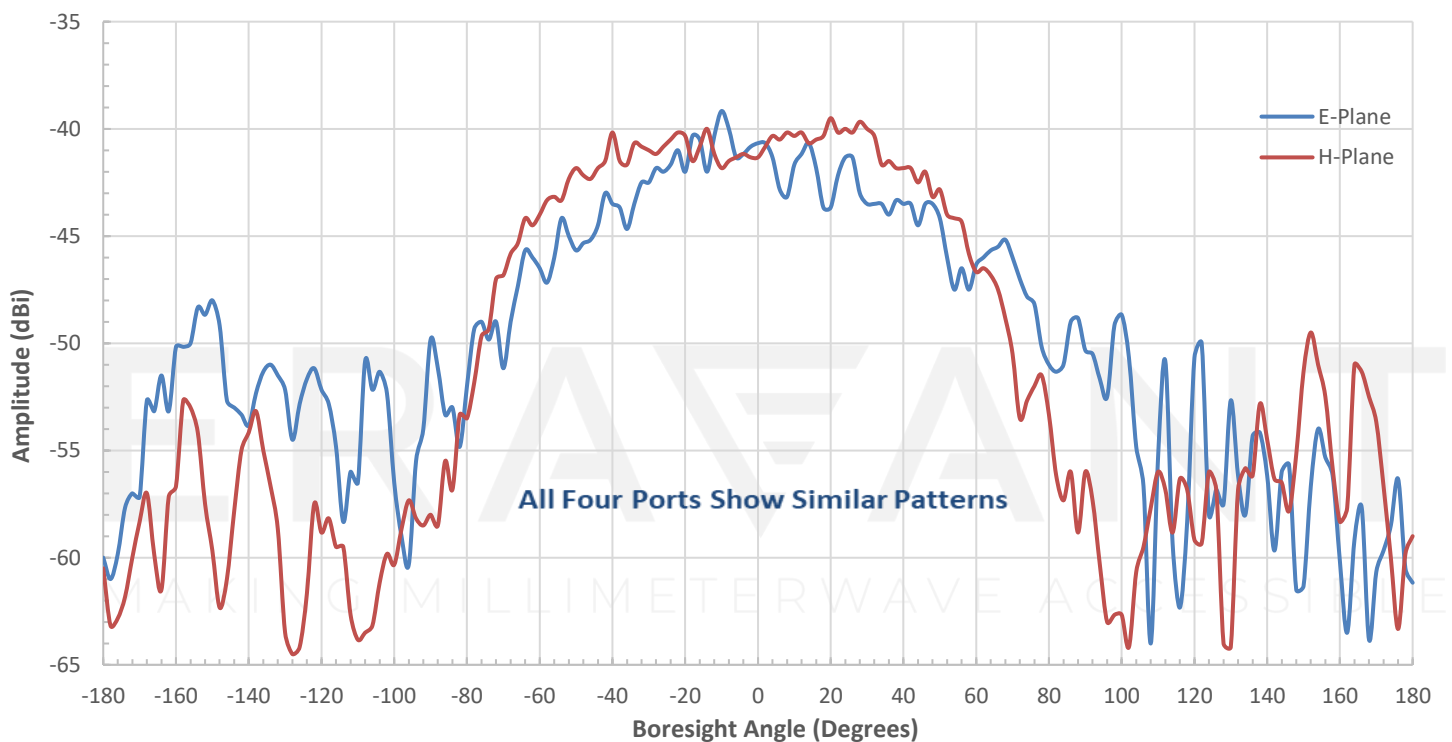

SAM-6837030395-15-L1-4W

V Band Microstrip Patch Array Antenna, 69 Ghz, 4 dBi, 50° x 95°

Measured Individual Patch Pattern @ 70.17 GHz

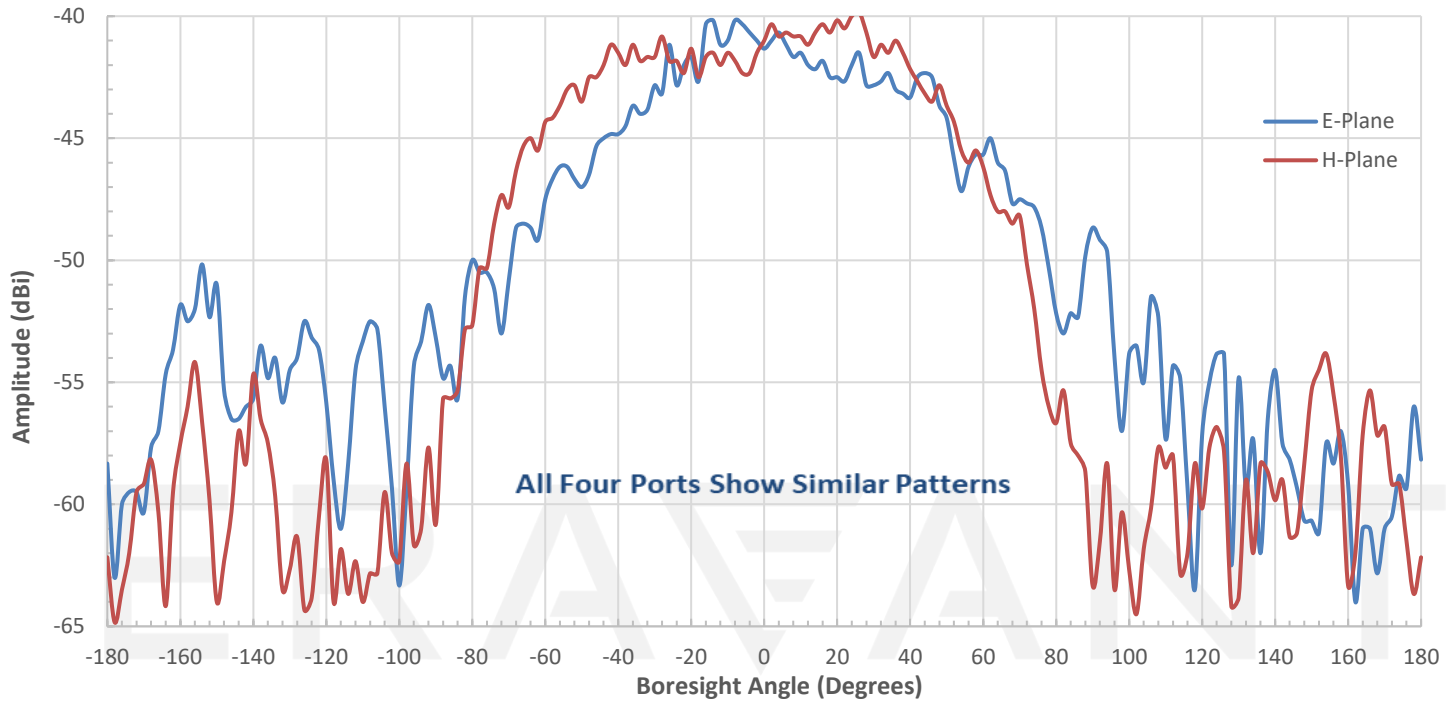

Measured Individual Patch Gain vs. Frequency

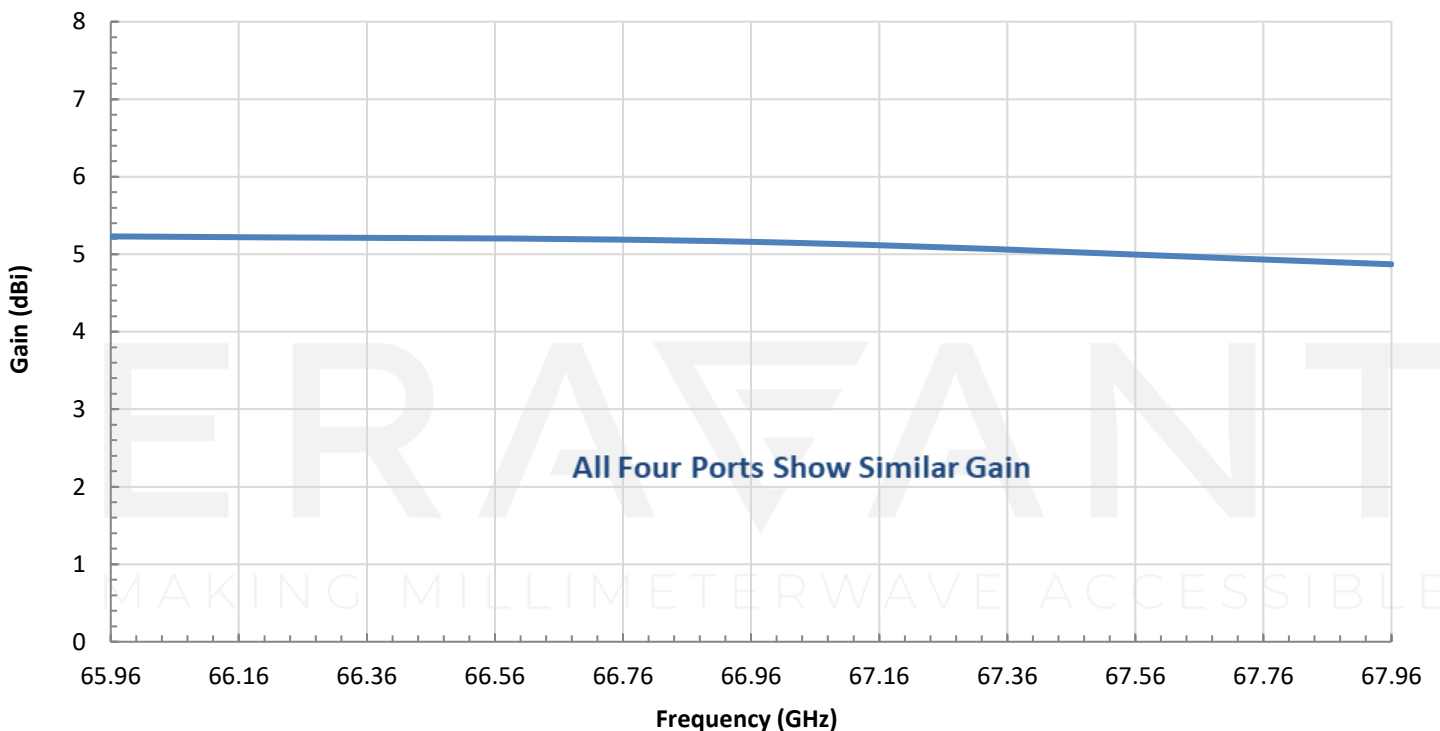

SAM-6837030395-15-L1-4W

V Band Microstrip Patch Array Antenna, 69 Ghz, 4 dBi, 50° x 95°

Measured Individual Patch Return Loss vs. Frequency

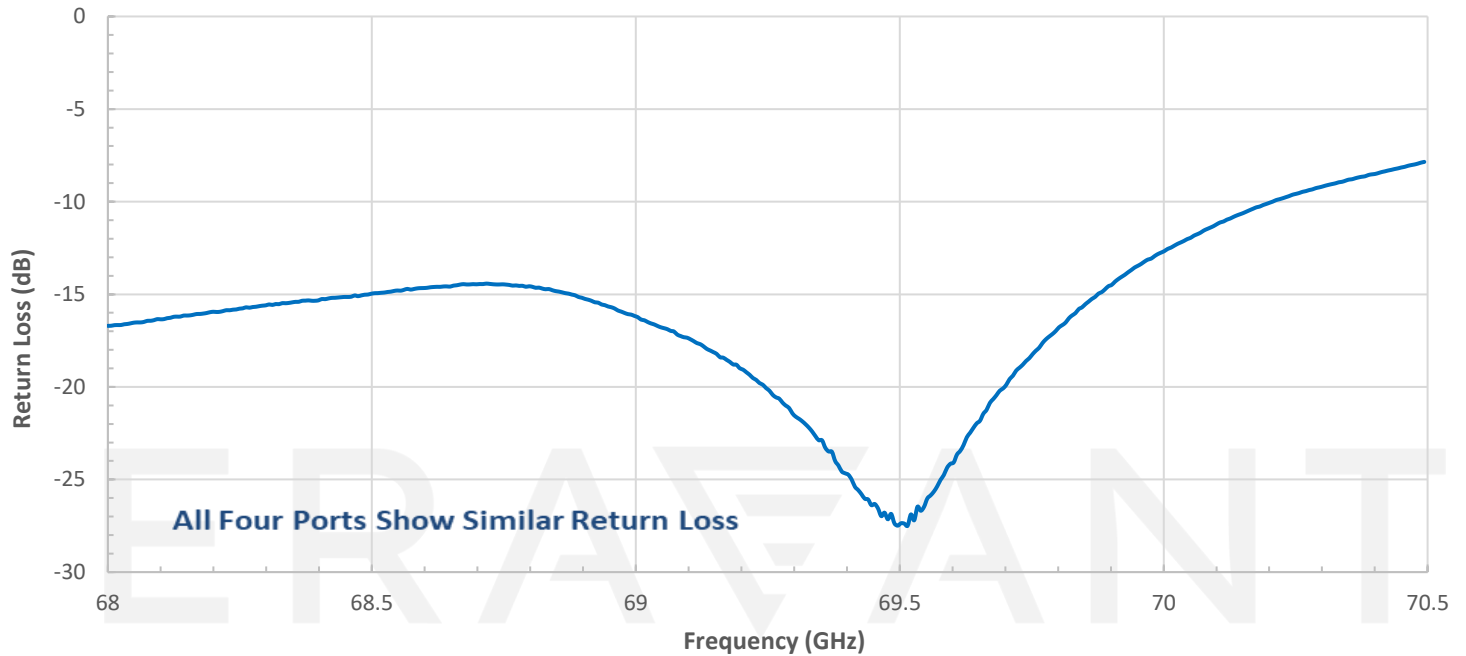

In-Phase Fed Simulated H-Plane Patch Array Antenna Pattern @ 69 GHz

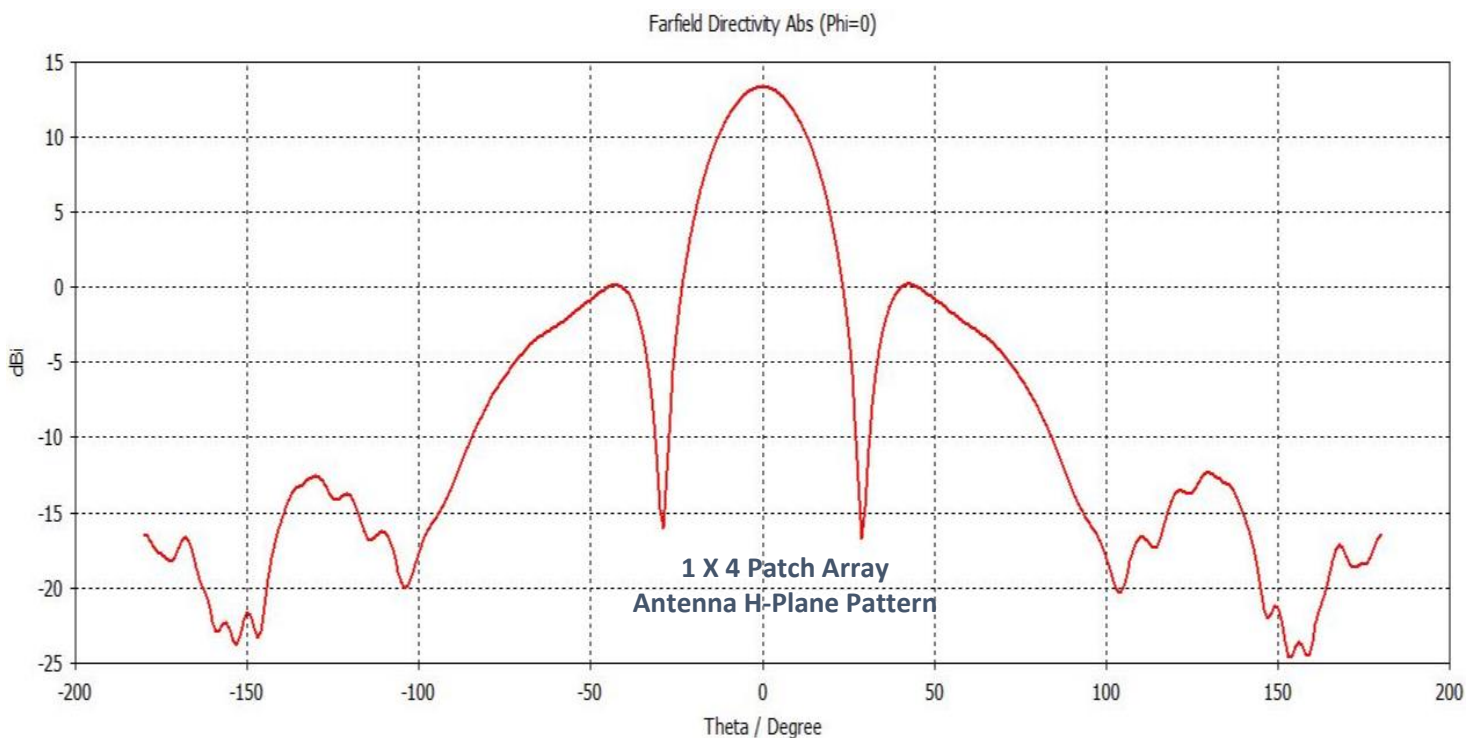

SAM-6837030395-15-L1-4W

V Band Microstrip Patch Array Antenna, 69 Ghz, 4 dBi, 50° x 95°

In-Phase Fed Simulated E-Plane Patch Array Antenna Pattern @ 69 GHz

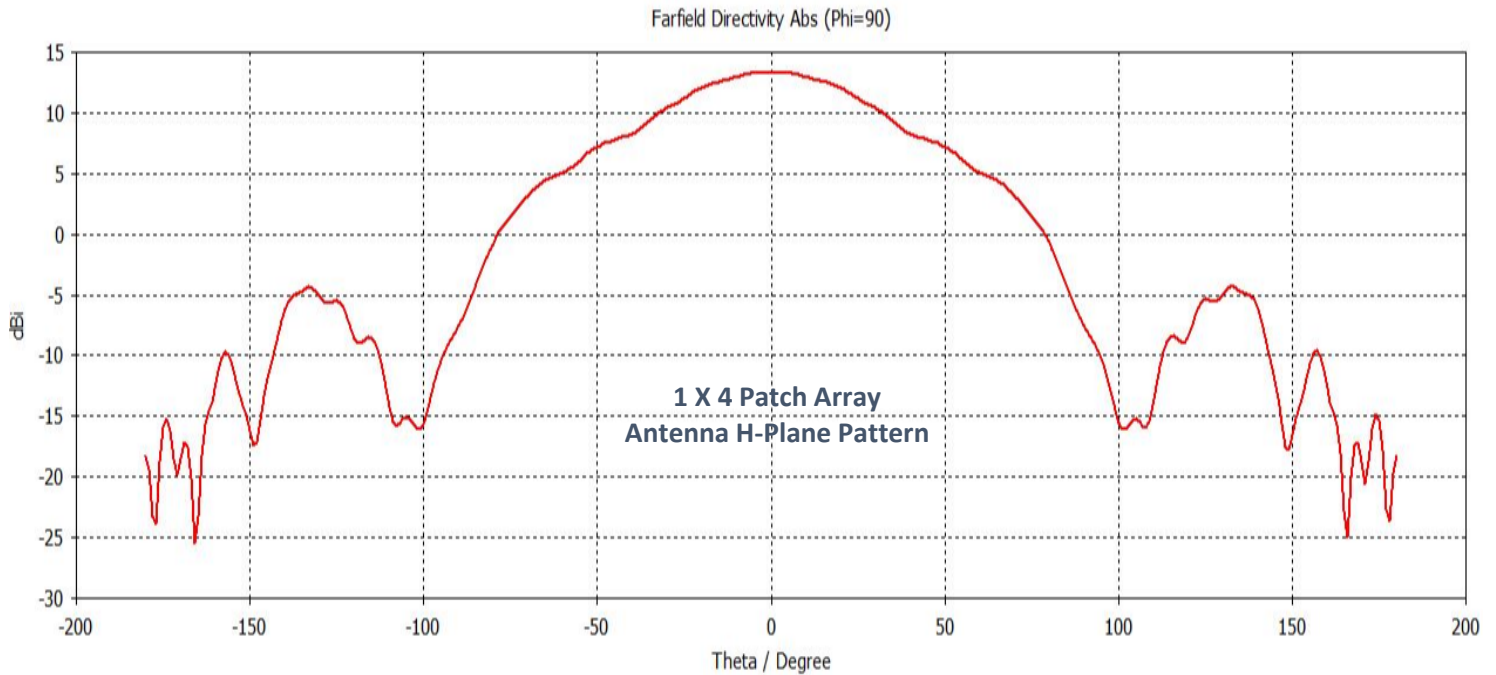

Mechanical Outline: (Unless otherwise specified, all dimensions are in inches [millimeters])

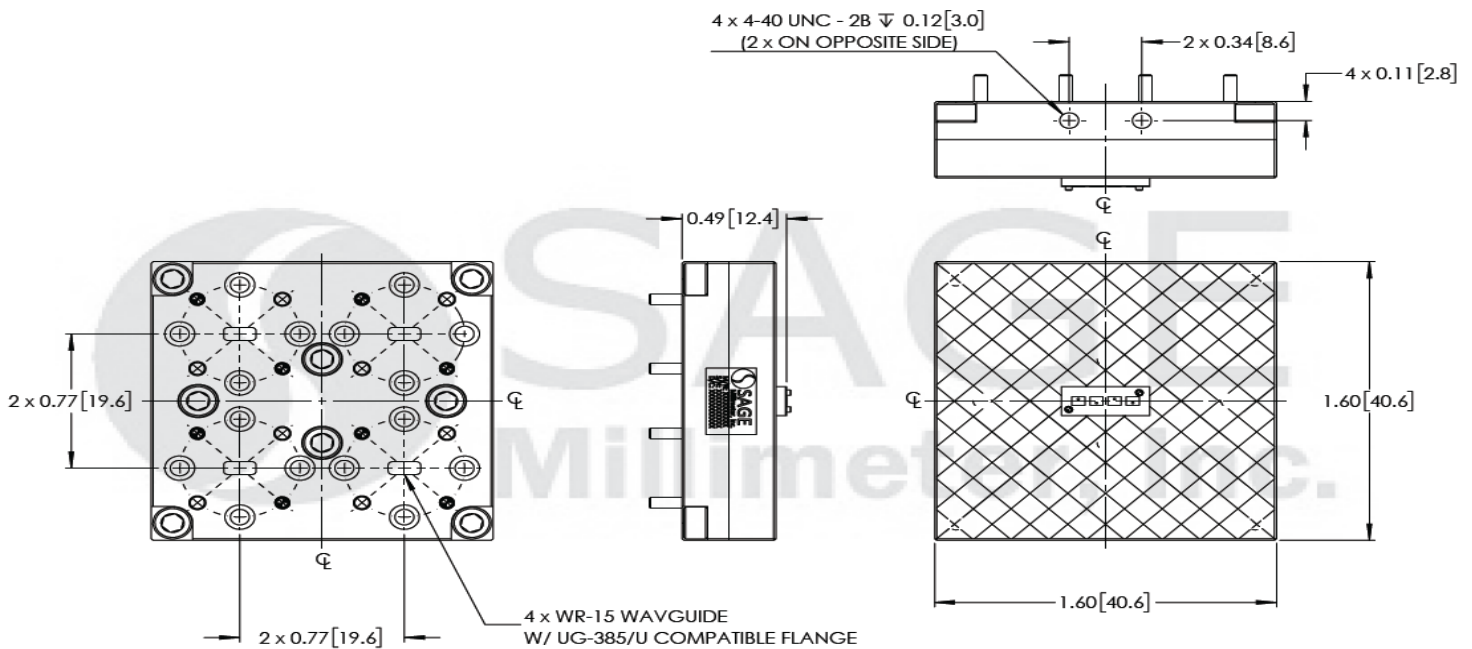

NOTES:

HATCHED AREA IS ECCOSORB



NOTE:

- Antenna Pattern, Gain and Return Loss data presented are for individual patch antennas and collected from a sample lot. Actual data may vary unit to unit, slightly.
- Combined Antenna Pattern data presented is simulated. Actual data may vary slightly.
- All testing is performed under +25 °C room temperature.
- Eravant reserves the right to change the information presented without notice.

CAUTION:

- If a waveguide is present, any foreign objects in the waveguide will cause performance degradation and may damage or destroy the unit.

ERAVANT
MAKING MILLIMETERWAVE ACCESSIBLE

ERAVANT
MAKING MILLIMETERWAVE ACCESSIBLE