

## SAM-6236430395-15-L2-4W

### V-Band Microstrip Patch Array Antenna, 63 Ghz, 4 dBi, 50° x 95°

**SAM-6236430395-15-L2-4W** is a linear polarized, 63 GHz microstrip patch 2 x 2 array antenna. The antenna array implements four individual antenna ports so that beamforming can be achieved via various input signal definitions. The individual patch antenna has a typical gain of 4 dBi, a vertical beamwidth of 50 degrees and horizontal beamwidth of 95 degrees, respectively. When all ports are fed with inphase and equal amplitude signals, the combined gain and beamwidth of the array are 12 dBi and 40 degrees, typically. The antenna is constructed with a high performing, low loss soft microwave substrate to achieve the best performance in the class. The RF interface is four WR-15 waveguides with UG-385/U compatible flanges.



#### Electrical Specifications

Parameter	Minimum	Typical	Maximum
Frequency Range	62 GHz		64 GHz
Gain (Individual Patch)		4.0 dBi	
3 dB Beamwidth (Individual Patch)	50° (Vertical, E Plane) x 95° (Horizontal, H Plane)		
Sidelobe Level (Individual Patch)		-12 dB	
Array Gain (Fed in Phase)		12.0 dBi	
Array 3 dB Beamwidth (Fed in Phase)	40° (Vertical, E Plane) x 50° (Horizontal, H Plane)		
Array Sidelobe Level (Fed in Phase)		-12 dB	
Polarization		Linear	
Return Loss		8 dB	
Specification Temperature		+25°C	
Operating Temperature	-40°C		+85°C

#### Mechanical Specifications:

Item	Specification
Antenna Port	4 x WR-15 Waveguide with UG-385/U Compatible Flange
Number of Elements	2 (H) x 2 (V)
Baseplate Material	Aluminum
Patch Finish	Gold Plated
Weight	2.0 Oz
Size	1.60" (L) x 1.60" (W) x 0.49" (H)
Outline	AM-RV-9550-4W-2

#### ECCN

EAR99

#### FEATURES

- Compact Size
- Beamforming Feasibility
- Low Cost in Volume

#### APPLICATIONS

- 5G Systems
- Beamforming
- Communication Systems
- Probe Stations

#### SUPPLEMENTAL DETAILS



## SAM-6236430395-15-L2-4W

V Band Microstrip Patch Array Antenna, 63 GHz, 4 dBi, 50° x 95°

Measured Individual Patch Pattern @ 61.74 GHz

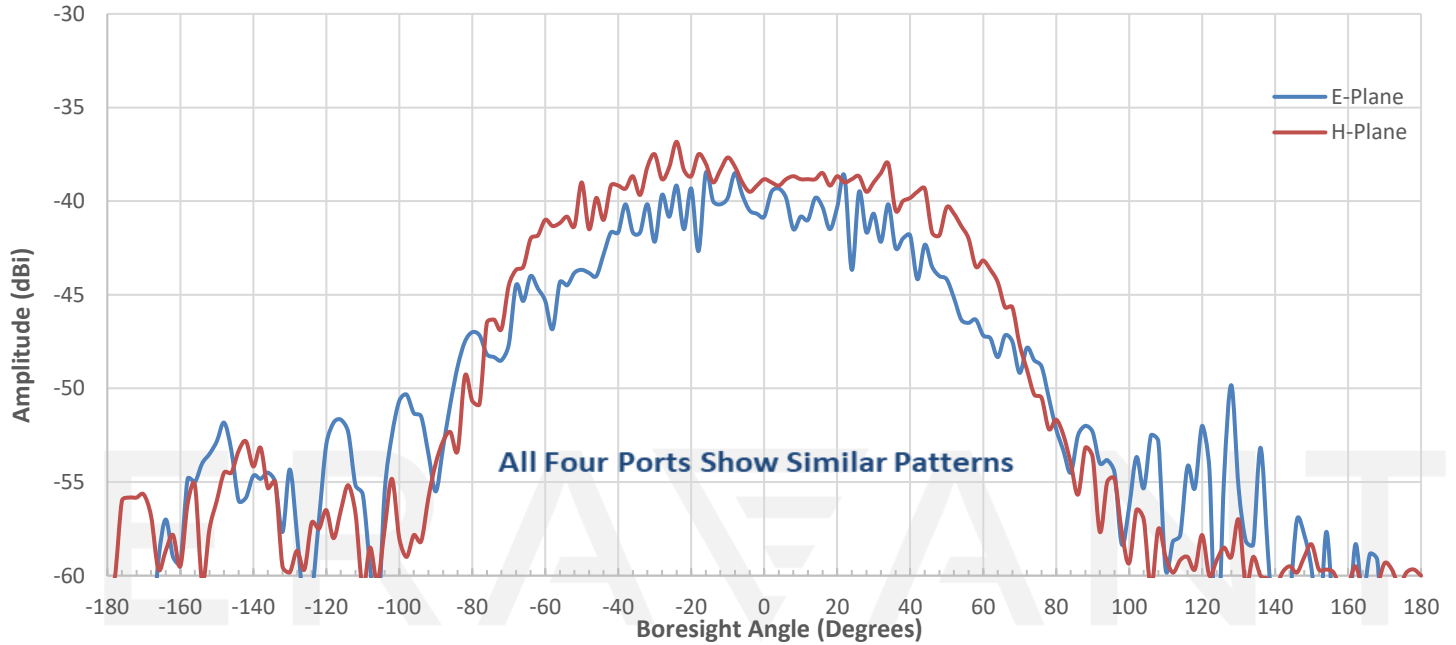

Measured Individual Patch Pattern @ 62.64 GHz

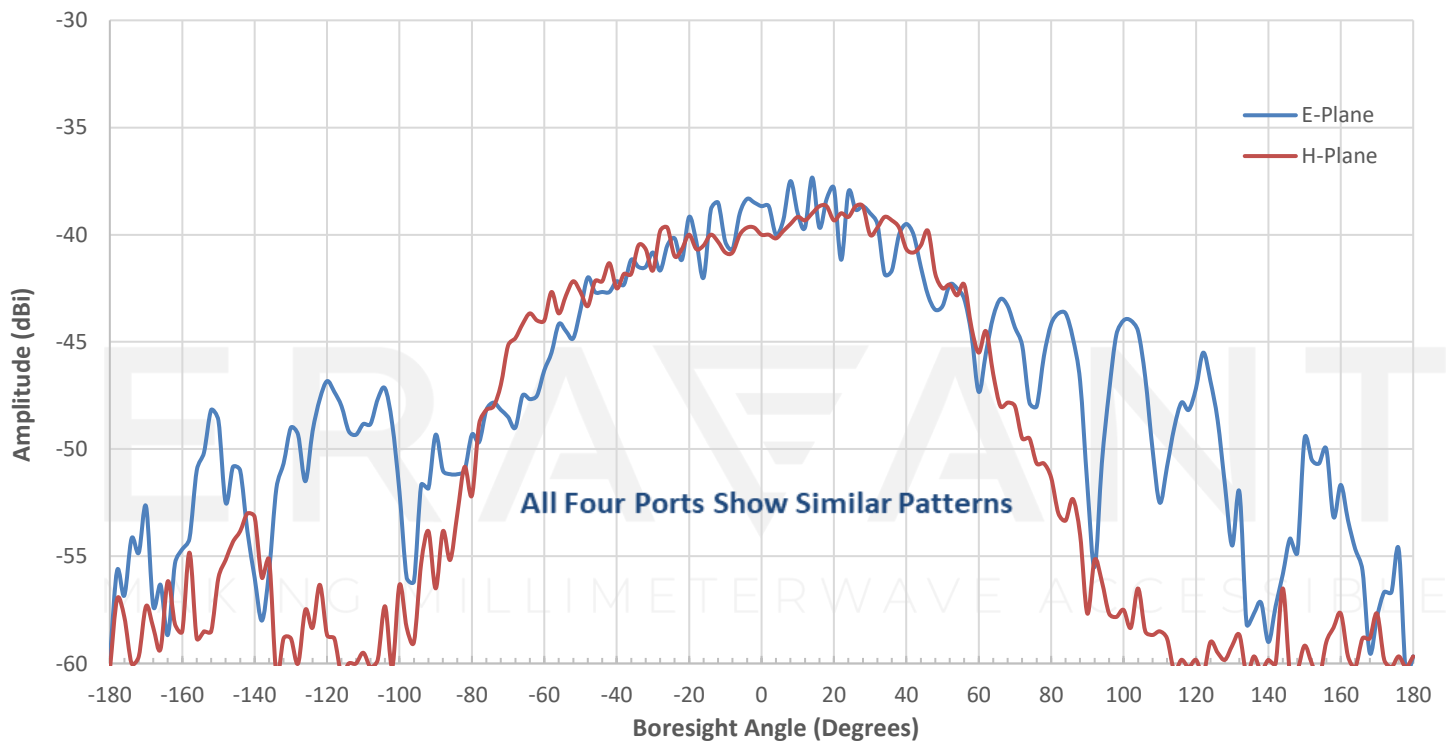

## SAM-6236430395-15-L2-4W

### V Band Microstrip Patch Array Antenna, 63 GHz, 4 dBi, 50° x 95°

#### Measured Individual Patch Pattern @ 63.5 GHz

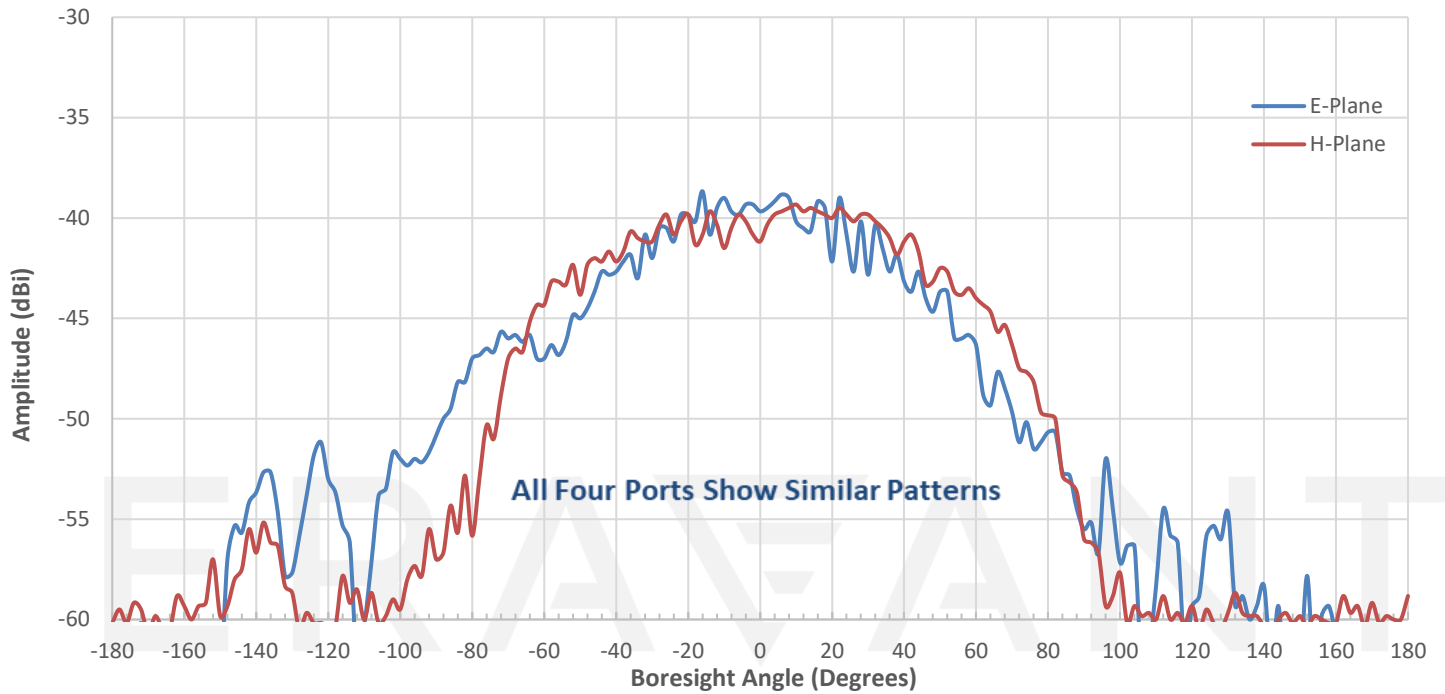

#### Measured Individual Patch Gain vs. Frequency

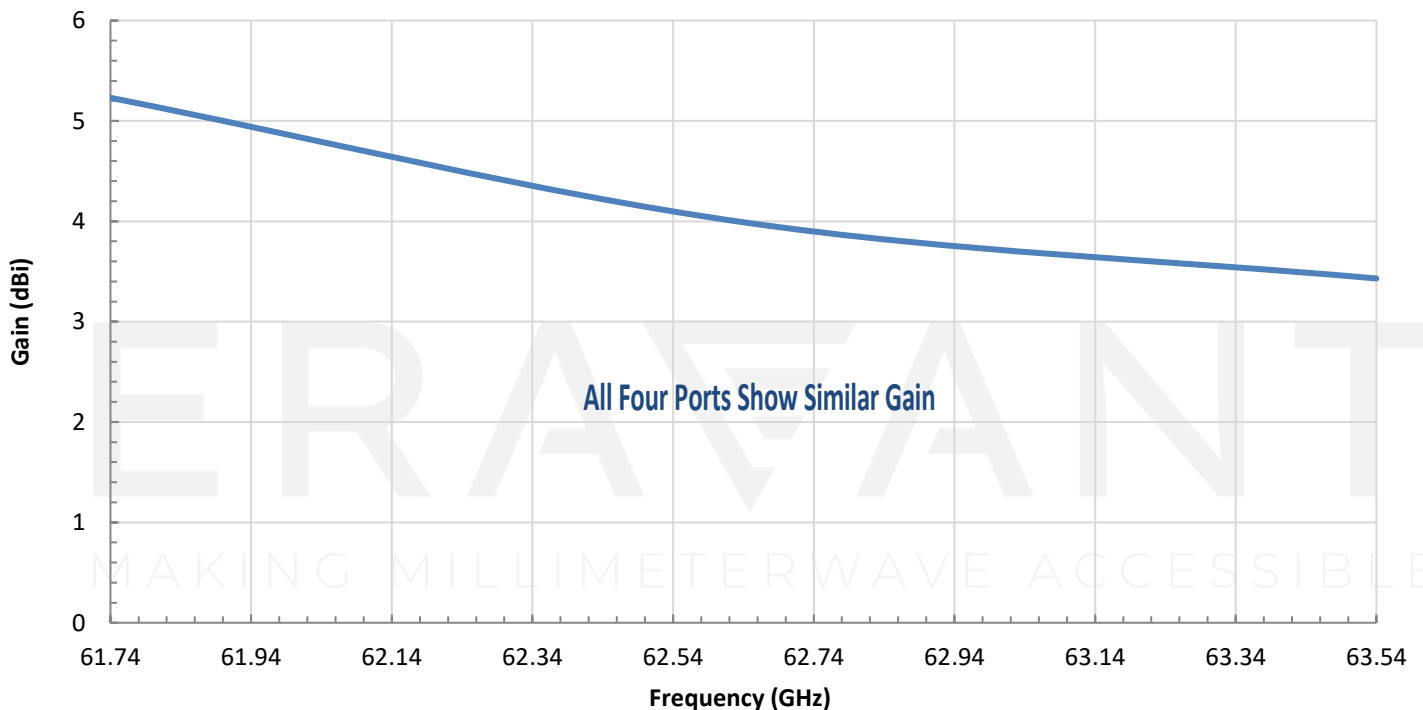

## SAM-6236430395-15-L2-4W

### V Band Microstrip Patch Array Antenna, 63 GHz, 4 dBi, 50° x 95°

#### Measured Individual Patch Return Loss vs. Frequency

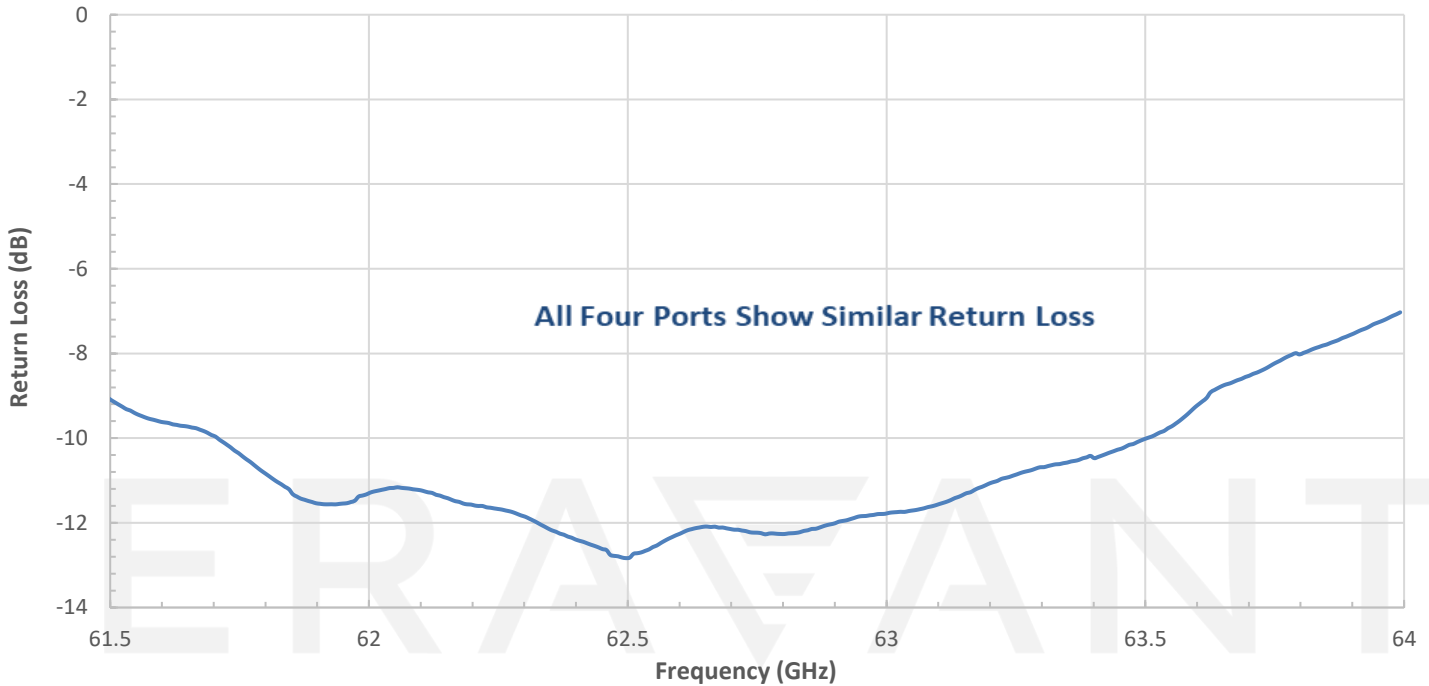

#### In-Phase Fed Simulated H-Plane Patch Array Antenna Pattern @ 63 GHz

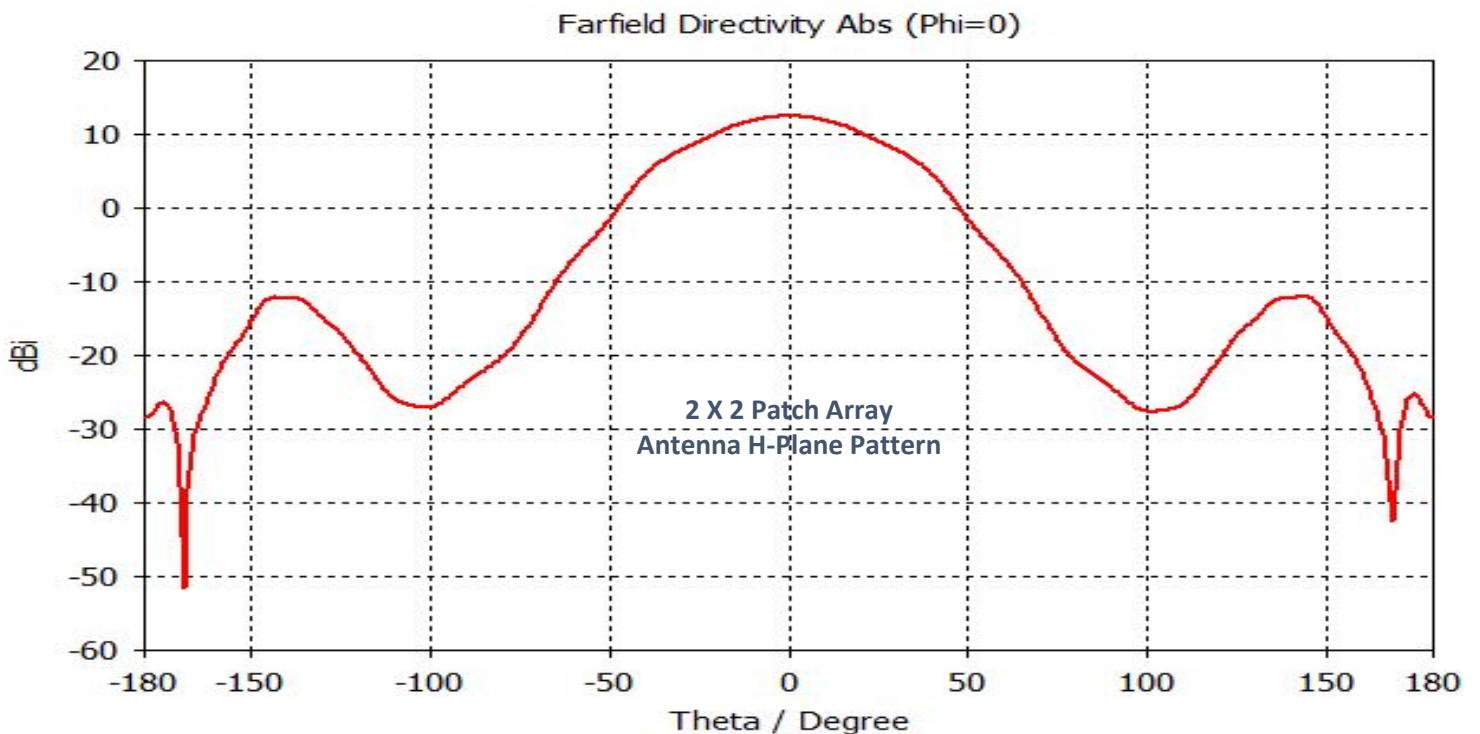

## SAM-6236430395-15-L2-4W

V Band Microstrip Patch Array Antenna, 63 GHz, 4 dBi, 50° x 95°

In-Phase Fed Simulated E-Plane Patch Array Antenna Pattern @ 63 GHz

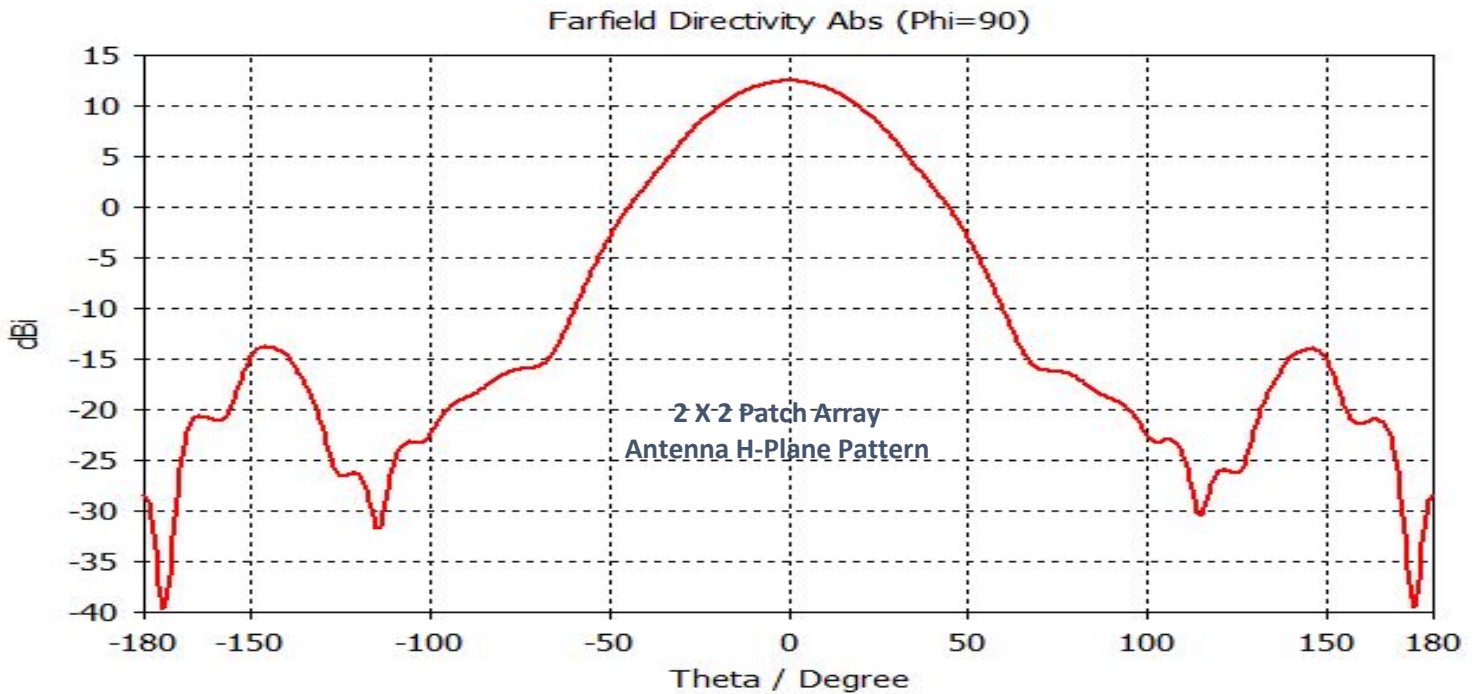

**Mechanical Outline:** (Unless otherwise specified, all dimensions are in inches [millimeters])

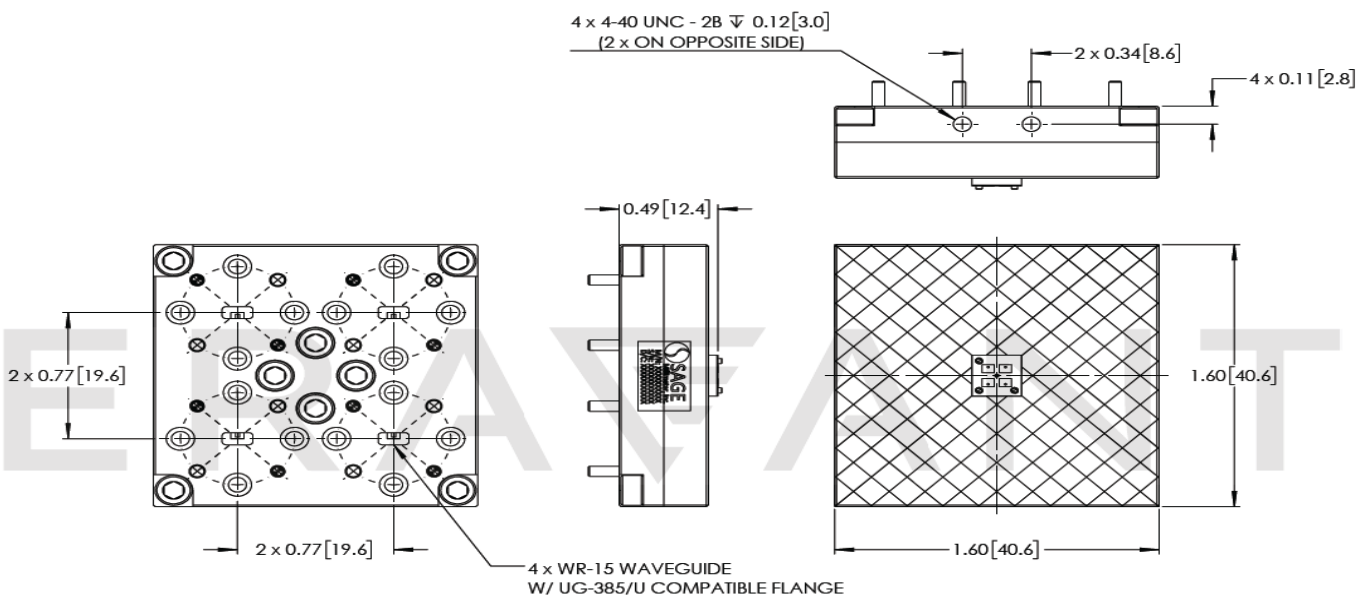

**NOTES:**

HATCHED AREA IS ECCOSORB



**NOTE:**

- Antenna Pattern, Gain and Return Loss data presented are for individual patch antennas and collected from a sample lot. Actual data may vary unit to unit, slightly.
- Combined Antenna Pattern data presented is simulated. Actual data may vary slightly.
- All testing is performed under +25 °C room temperature.
- Eravant reserves the right to change the information presented without notice.

**CAUTION:**

- If a waveguide is present, any foreign objects in the waveguide will cause performance degradation and may damage or destroy the unit.

ERAVANT  
MAKING MILLIMETERWAVE ACCESSIBLE

ERAVANT  
MAKING MILLIMETERWAVE ACCESSIBLE