



## V Band Microstrip Patch Array Antenna, 63 GHz, 4 dBi, 50° x 95°

### Description:

**Model SAM-6236430395-15-L1-4W** is a linear polarized, 63 GHz microstrip patch 4 x 1 array antenna. The antenna array implements four individual antenna ports so that beamforming can be achieved via various input signal definitions. The individual patch antenna has a typical gain of 4 dBi, a vertical beamwidth of 50 degrees and horizontal beamwidth of 95 degrees, respectively. When all ports are fed with in-phase and equal amplitude signals, the combined gain and beamwidth of the array are 12 dBi and 40 degrees, typically. The antenna is constructed with a high performing, low loss soft microwave substrate to achieve the best performance in the class. The RF interface is four WR-15 waveguides with UG-385/U compatible flanges.



### Features:

- Compact Size
- Beamforming Feasibility
- Low Cost in Volume

### Applications:

- 5G Systems
- Beamforming
- Communication Systems
- Probe Stations

### Electrical Specifications:

Parameter	Minimum	Typical	Maximum
Frequency Range	62 GHz		64 GHz
Gain (Individual Patch)		4.0 dBi	
3 dB Beamwidth (Individual Patch)	50° (Vertical, E Plane) x 95° (Horizontal, H Plane)		
Sidelobe Level (Individual Patch)		-12 dB	
Array Gain (Fed in Phase)		12.0 dBi	
Array 3 dB Beamwidth (Fed in Phase)	40° (Vertical, E Plane) x 50° (Horizontal, H Plane)		
Array Sidelobe Level (Fed in Phase)		-12 dB	
Polarization		Linear	
Return Loss		10 dB	
Specification Temperature		+25 °C	
Operating Temperature	-40 °C		+85 °C

### Mechanical Specifications:

Item	Specifications
Antenna Port	4 x WR-15 Waveguide with UG-385/U Compatible Flange
Number of Elements	4 (H) x 1 (V)
Baseplate Material	Aluminum
Patch Finish	Gold Plated
Weight	2.0 Oz
Size	1.60" (L) x 1.60" (W) x 0.49" (H)
Outline	AM-RV-9550-4W

www.sagemillimeter.com | 3043 Kashiwa Street, Torrance, CA 90505  
 Phone: 424-757-0168 | Fax: 424-757-0188 | Email: sales@sagemillimeter.com



## V Band Microstrip Patch Array Antenna, 63 GHz, 4 dBi, 50° x 95°

### Measured Individual Patch Pattern @ 61.74 GHz

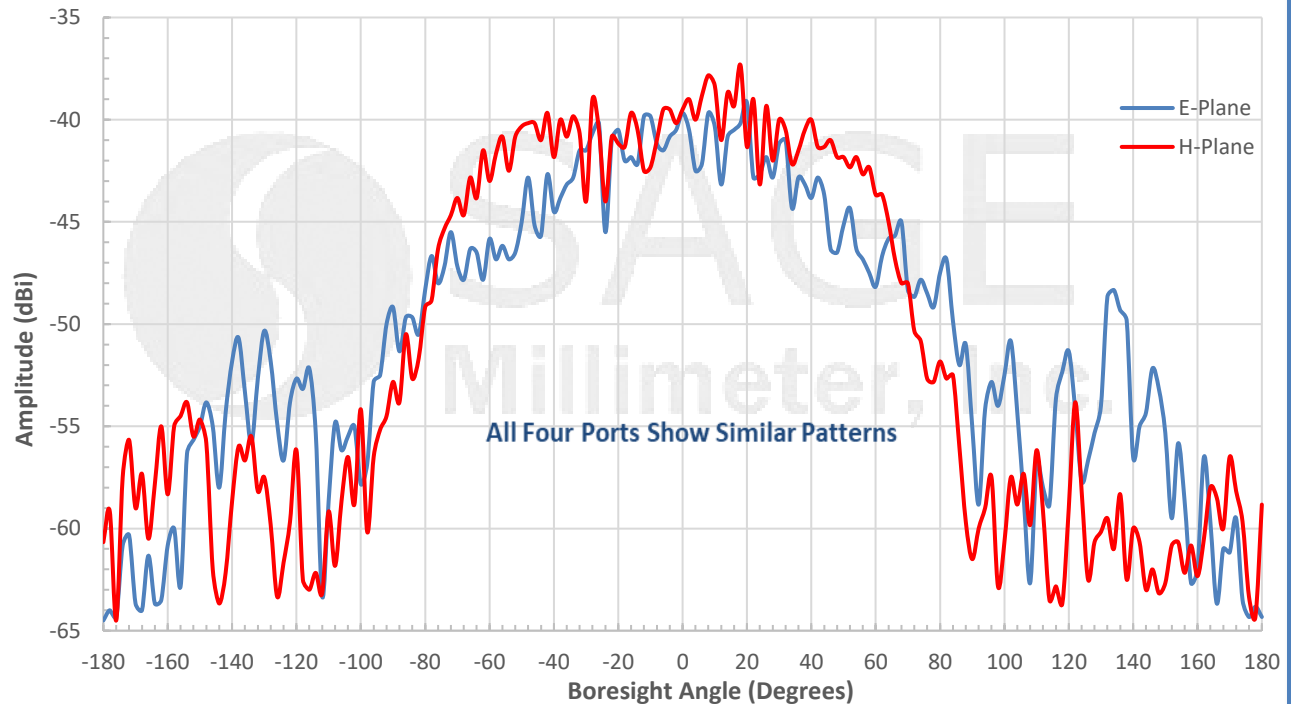

### Measured Individual Patch Pattern @ 62.64 GHz

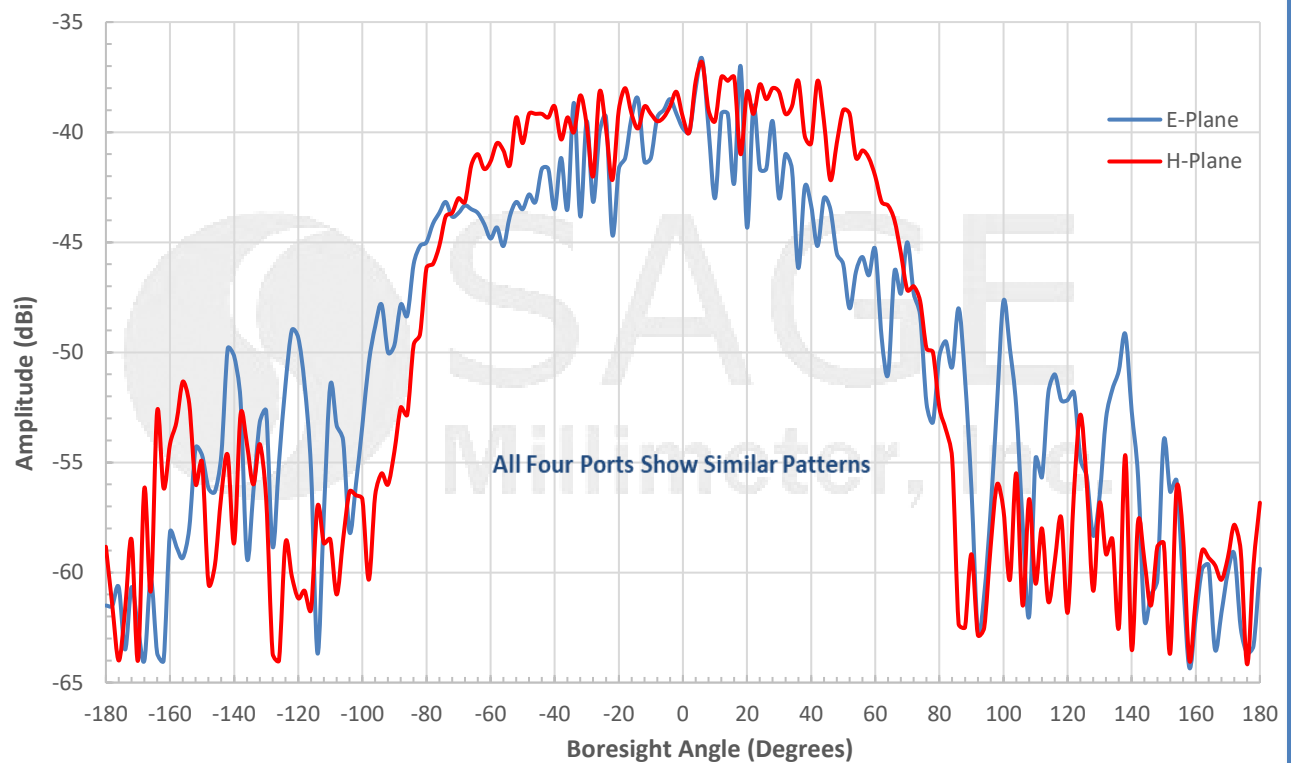



## V Band Microstrip Patch Array Antenna, 63 GHz, 4 dBi, 50° x 95°

### Measured Individual Patch Pattern @ 63.5 GHz

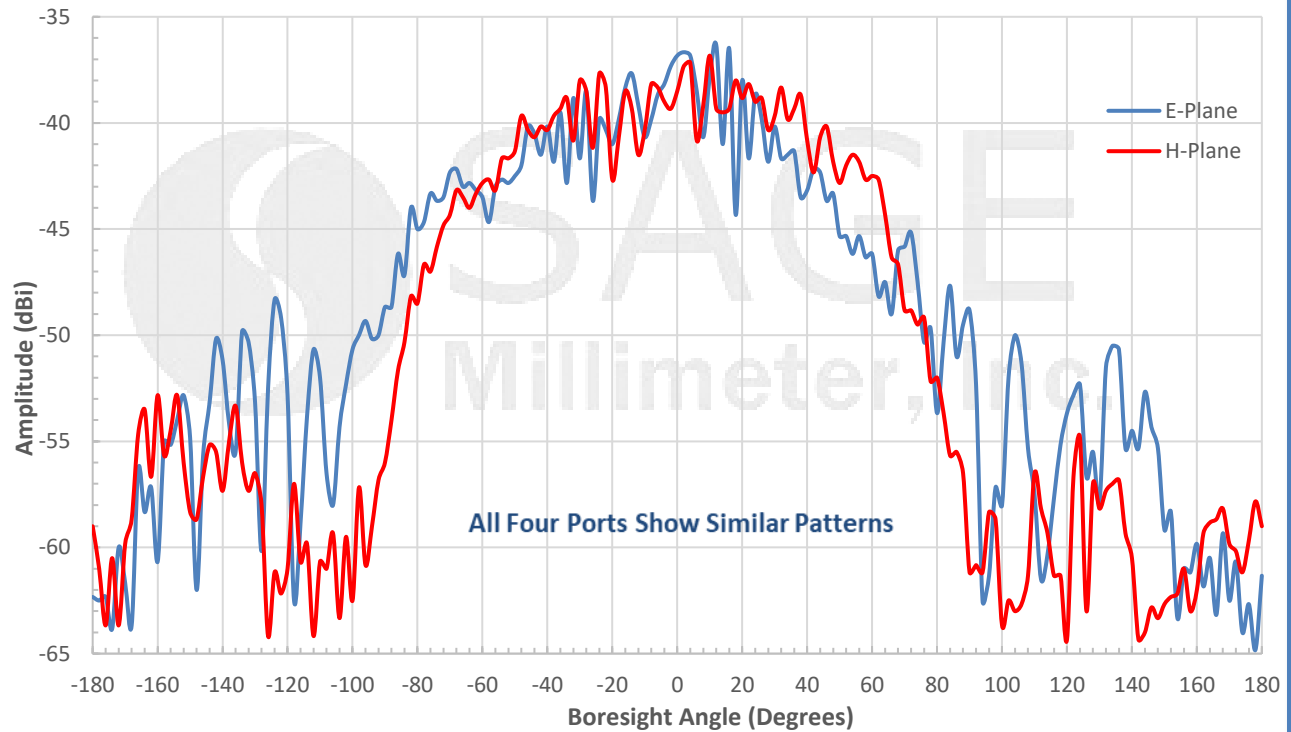

### Measured Individual Patch Gain vs. Frequency

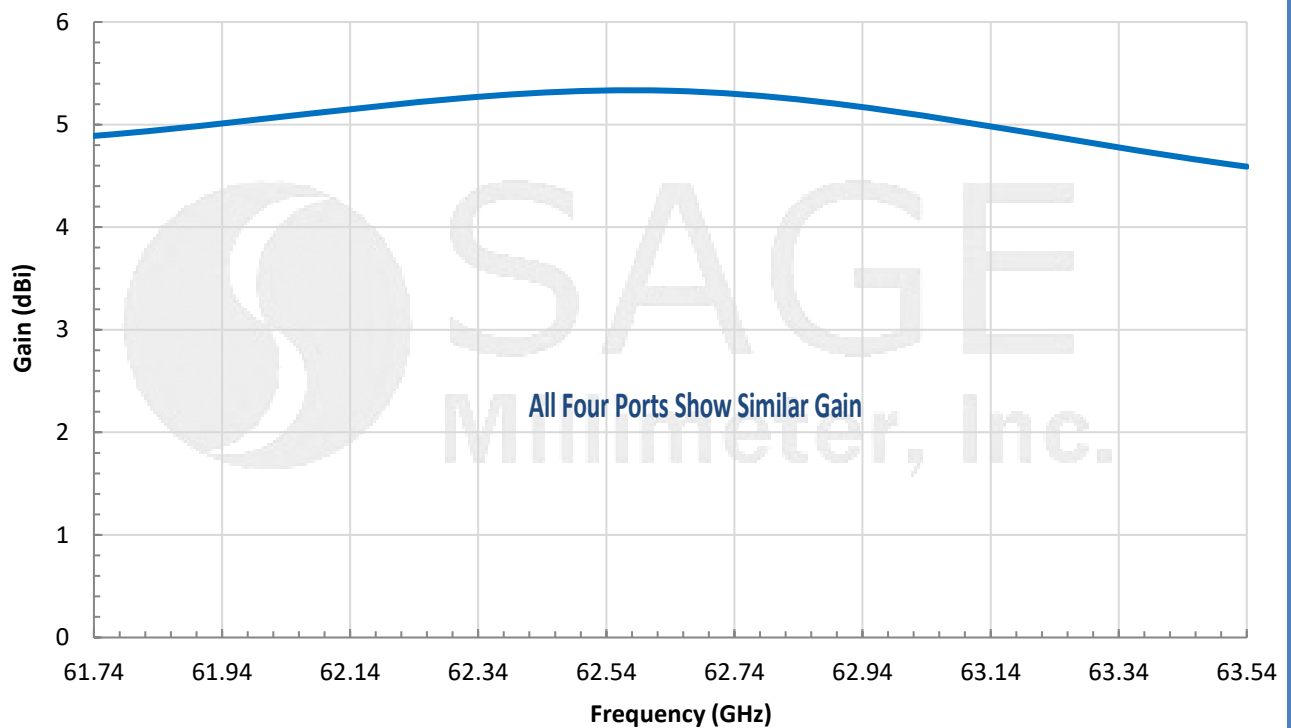



## V Band Microstrip Patch Array Antenna, 63 GHz, 4 dBi, 50° x 95°

### Measured Individual Patch Return Loss vs. Frequency

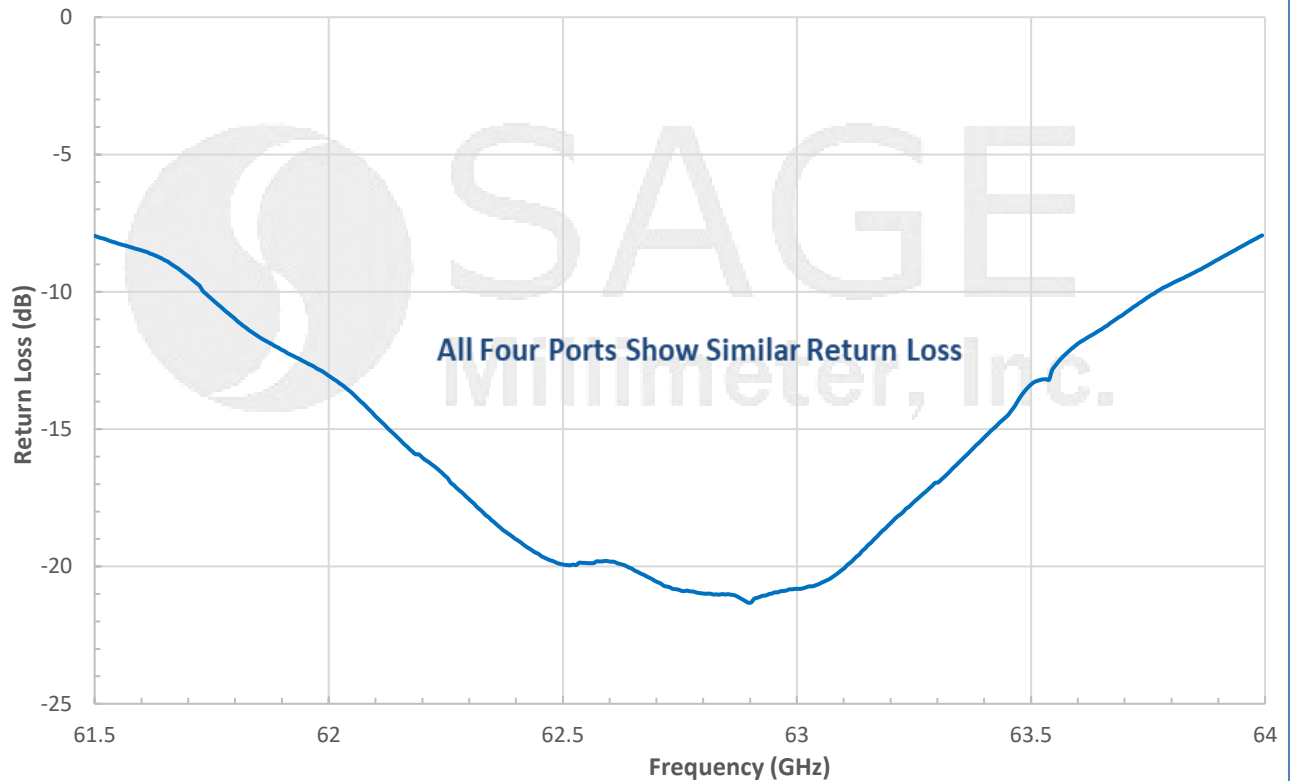

### In-Phase Fed Simulated H-Plane Patch Array Antenna Pattern @ 63 GHz

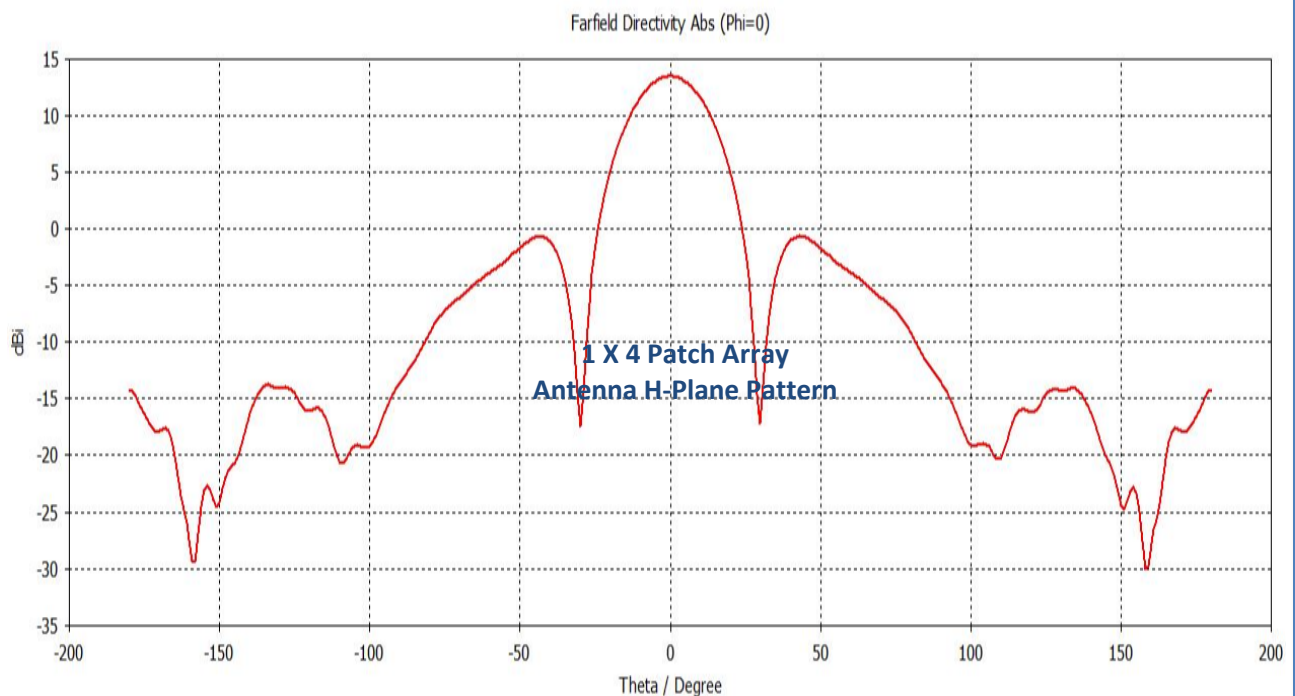

www.sagemillimeter.com | 3043 Kashiwa Street, Torrance, CA 90505  
Phone: 424-757-0168 | Fax: 424-757-0188 | Email: sales@sagemillimeter.com



## V Band Microstrip Patch Array Antenna, 63 GHz, 4 dBi, 50° x 95°

### In-Phase Fed Simulated E-Plane Patch Array Antenna Pattern @ 63 GHz

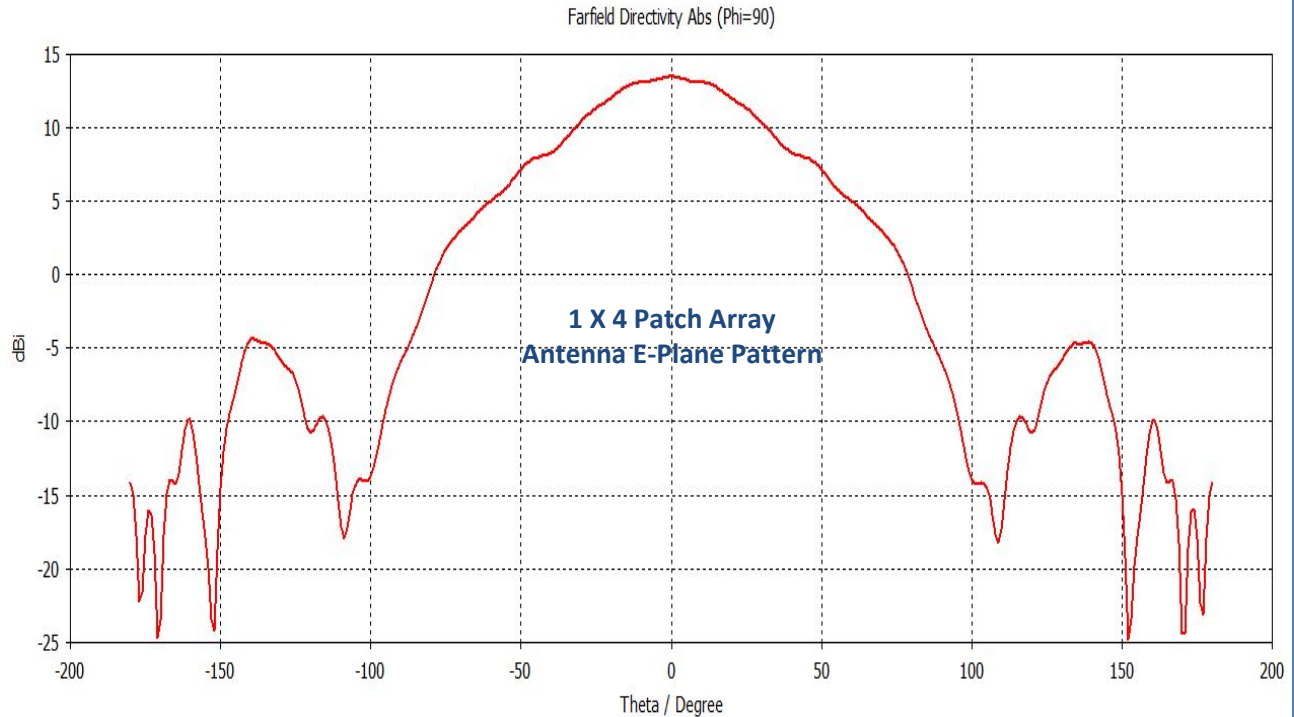

### Mechanical Outline: (Unless otherwise specified, all dimensions are in inches [millimeters])

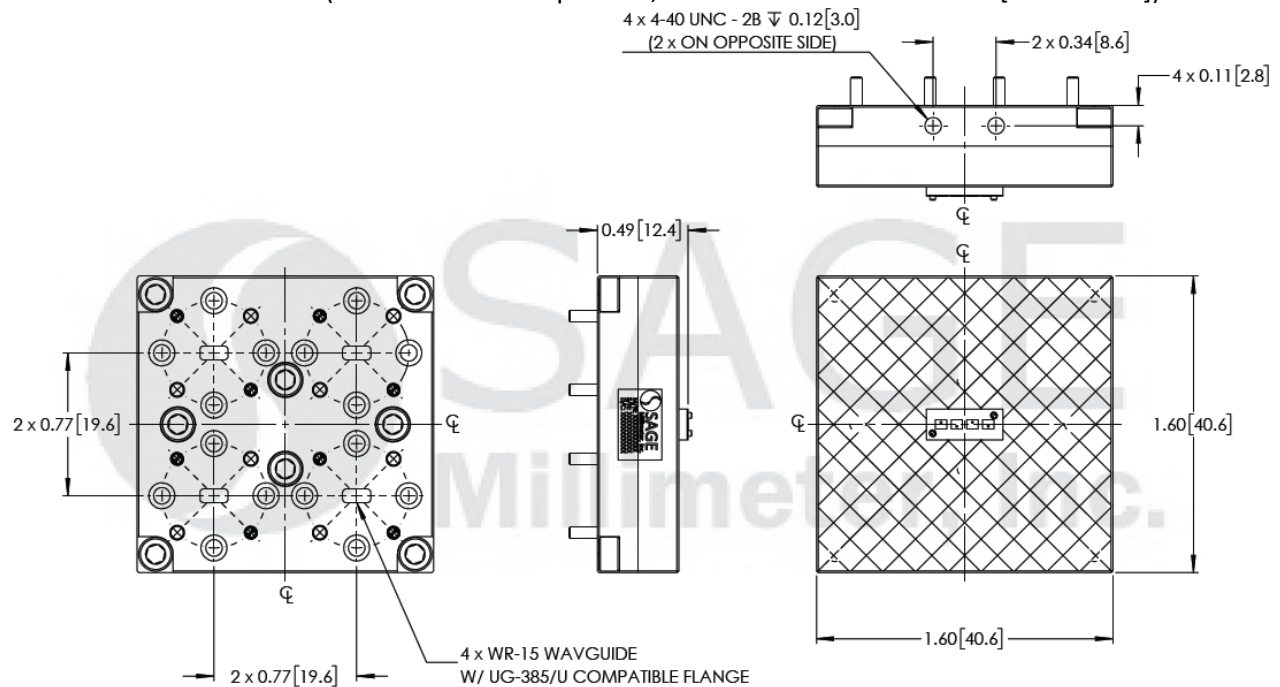

NOTES:

HATCHED AREA IS ECCOSORB

## V Band Microstrip Patch Array Antenna, 63 GHz, 4 dBi, 50° x 95°

**Note:**

- Antenna Pattern, Gain and Return Loss data presented are for individual patch antennas and collected from a sample lot. Actual data may vary unit to unit, slightly.
- Combined Antenna Pattern data presented is simulated. Actual data may vary slightly.
- All testing was performed under +25 °C room temperature.
- SAGE Millimeter, Inc. reserves the right to change the information presented without notice.

**Caution:**

- Any foreign objects in the waveguide will cause performance degradation and possible device damage.

